

Contract Documents

Knott Landfill Compost Facility Relocation Project



Deschutes County
Department of Solid Waste
61050 SE 27th Street
Bend, Oregon 97702

February 2016

TABLE OF CONTENTS

| | ITEM | NUMBER OF PAGES |
|-----------|---|-----------------|
| Part I | Invitation to Bid | 1 |
| Part II | Information for Bidders | 6 |
| Part III | General Conditions | 8 |
| Part IV | Special Provisions | 30 |
| Part V | Bid Proposal Forms | |
| | Bid Proposal | 1 |
| | Bid Schedule | 3 |
| | Bid Bond | 1 |
| | Subcontractor Disclosure | 1 |
| Part VI | Agreement Forms | |
| | Contract | 2 |
| | Performance Bond | 2 |
| | Payment Bond | 2 |
| | Insurance Requirements | 2 |
| Part VII | Conditional Use Permit for Aggregate Production and Storage at Knott Landfill | 19 |
| Part VIII | Project Drawings | 13 |

Deschutes County, Oregon
Department of Solid Waste
PART I-INVITATION TO BID
Knott Landfill Compost Facility Relocation Project

Sealed bids will be received at the Deschutes County Department of Solid Waste, 61050 SE 27th Street, Bend, Oregon 97702, until but not after, 2:00 p.m. on Thursday, March 17, 2016; at which time all bids for the above-entitled public works project will be publicly opened and read aloud. Bidders must submit a First Tier Subcontractor Disclosure Statement Form. The Subcontractor Disclosure Statement may be submitted in the sealed bid prior to 2:00 p.m. on Thursday, March 17, 2016 or in a separate sealed envelope marked "FIRST TIER SUBCONTRACTOR DISCLOSURE STATEMENT-KNOTT LANDFILL COMPOST FACILITY RELOCATION PROJECT prior to 4:00 p.m. on Thursday, March 17, 2016 at the above location.

Said work is to be performed at Knott Landfill, 61050 SE 27th Street in Deschutes County, Oregon and shall include: Excavation and placement of embankment material, excavation of stormwater pond, construction of primary electrical service facilities, construction of secondary electrical service facilities, construction of irrigation water distribution system, and performance of such additional and incidental work as specified in the plans and specifications. The estimated construction cost is \$250,000.

Plans, specifications and other bid documents may be inspected at the Deschutes County Bids and RFPs web page (<http://www.deschutes.org/rfps>) or obtained from Deschutes County Department of Solid Waste (541-317-3163), 61050 SE 27th Street, Bend, Oregon 97702, for a fee of \$50.00, which is not refundable. If bidder prefers to have plans and specifications mailed, bidder must include an additional \$5.00 with the request. Should expedited handling be desired, Federal Express or equivalent service will be utilized on a collect on delivery basis. Inquiries pertaining to this project shall be directed to Chad Centola, Operations Manager at (541) 322-7172 or chadc@deschutes.org.

IMPORTANT: Prospective bidders downloading/accessing website-posted project plans, specifications and other bid documents MUST complete and submit the Contact Information Form provided on the website, or contact the Department of Solid Waste by telephone (541-317-3163), to provide contact information, to receive follow-up documents (addenda, clarifications, etc). Failure to provide contact information to the Department of Solid Waste will result in bidder disqualification. Only pre-bid meeting attendees and those notifying the Department of Solid Waste of website access to the project plans and specifications will receive follow-up documents (addenda, clarifications, etc).

A pre-bid meeting will be held at 10:00 a.m. on Thursday March 10, 2016 at the Department of Solid Waste Office which is located at 61050 SE 27th Street, Bend, Oregon. All bidders are encouraged to attend.

Bids shall be made on the forms furnished by the County, incorporating all contract documents, including a Bid Bond or Cashier's Check for the minimum amount of 10% of the Bid Price, addressed and mailed or delivered to Deschutes County Department of Solid Waste, 61050 SE 27th Street, Bend, Oregon 97702 in a sealed envelope plainly marked "Knott Landfill Compost Facility Relocation Project" and the name and address of the bidder.

No bid will be considered by Deschutes County unless the bid contains a statement by the bidder that the provisions of ORS 279C.800 – 279C.870 are to be complied with. Each bid must contain a statement as to whether the bidder is a resident bidder, as defined in ORS 279A.120. Vendors shall use recyclable products to the maximum extent economically feasible in the performance of the contract work set forth in this document.

Bidders shall be prequalified with the State of Oregon in accordance with ORS 279C.430 – 279C.450 and Deschutes County Code 12.52.0020. The prequalification classification required for this project is "EART-Earthwork and Drainage." The successful bidders and subcontractors providing labor shall maintain a qualified drug testing program for the duration of the contract. Bidders shall be registered with the Construction Contractor's Board. Contractors and subcontractors need not be licensed under ORS 468A.720.

Deschutes County may reject any bid not in compliance with all prescribed bidding procedures and requirements, and may reject for good cause any or all bids upon a finding of Deschutes County it is in the public interest to do so. The protest period for this procurement is seven (7) calendar days.

Timm Schimke,
Director of Solid Waste

PUBLISHED:

THE BEND BULLETIN: Wednesday, March 2, 2016 and Monday, March 7, 2016

DAILY JOURNAL OF COMMERCE: Friday, March 4, 2016 and Monday March 7, 2016

PART II - INFORMATION FOR BIDDERS

1. **General Description of Project.** A general description of the work to be performed is contained in the Invitation to Bid. The scope is indicated in the applicable parts of these Contract documents.
2. **Contract Documents.** The Contract documents under which it is proposed to execute the work consist of the material bound herewith. These Contract documents are intended to be mutually complementary and to provide all details reasonably required for the execution of the proposed work.

Any person contemplating the submission of a proposal and being in doubt as to the meaning or intent of said contract document shall at once notify, in writing, the Solid Waste Department Director of Deschutes County, Oregon. Any interpretation of change will be mailed or delivered to each person receiving a set of documents.

3. **Form of Proposals.** All proposals must be submitted on the forms furnished. Subcontractor disclosure form may be submitted with bid or in a separate envelope.
4. **Substitutions.** Materials and/or products called for in the specifications are named in order to establish standards of quality and design. Manufacturers or suppliers of such products similar to those specified may submit bids on the work providing requests for approval of substitution materials are made at least seven (7) calendar days prior to the bid opening. Adequate information on which to base approval or disapproval must be furnished to the Solid Waste Department Director or his representative and the Solid Waste Department shall be the sole judge of any request. When the Solid Waste Director approves a substitution, it is with the understanding that the Contractor guarantees the substituted article or materials to be equal to or better than that specified.
5. **Preparation of Proposals.** All blank spaces in the proposal form must be filled in, in ink, or typed, in both words and figures where required. No changes shall be made in phraseology of the forms. Written amount shall govern in cases of discrepancy between the amount stated in writing and amount stated in figures.

Any proposal shall be deemed informal which contains omissions, erasures, alterations, or additions of any kind, or prices uncalled for, or which, in any manner shall fail to conform to the conditions of the published invitation to bidders.

The bidder shall sign his proposal in the blank space provided therefore. Proposals made by corporations or partnerships shall contain names and addresses of the principal officers or partners therein. If a corporation makes a proposal, it must be signed by one of the principal officers thereof, and the corporate seal affixed.

If made by a partnership, it must be signed by one of the partners, clearly indicating that he is signing as a partner of the firm. In the case of a proposal made by a joint venture, each of the joint venturers must sign the proposal in his personal capacity.

The wording of the proposal shall not be changed. Any additions, conditions, limitations or provisions inserted by the bidder will render the proposal irregular and may cause its rejection.

All Bids must be submitted on the Bid Proposal Forms attached hereto as Part V of these Contract Documents.

6. **Submission of Proposals.** All proposals must be submitted in the time and place and in the manner prescribed in the Invitation to Bid. Proposals must be made on the prescribed proposal forms furnished. Each proposal must be submitted in a sealed envelope, so marked as to indicate its contents without being

opened. If the proposal is submitted by mail, the sealed envelope containing the bid must be enclosed in a separate envelope plainly addressed for mailing to conformance with instructions in the Invitation to Bid. **NOTE: A proposal must include completed original set of all forms provided in Part V-Bid Proposal Forms of these Contract Documents.**

7. **Modification or Withdrawal of Proposal.** Any bidder may modify his bid by written or electronic (facsimile or email) communication at any time prior to the scheduled closing time for receipt of bids, provided such communication is received by the County prior to the bid closing time, and provided further that a written confirmation of an electronic modification over the signature of the bidder was mailed prior to the bid closing time. If written confirmation of an electronic communication is not received within at least two calendar days of the closing time, no consideration will be given to the modification. The written or electronic communication should not reveal the bid price, but should state the addition or subtraction or other modification so that the County will not know the final prices or terms until the sealed bid is opened.

Proposals may be withdrawn prior to the scheduled time for the opening of the proposals either by telecommunication (facsimile) or written request, or in person. No proposal may be withdrawn after the time scheduled for opening of proposals, unless the County has failed to comply with the time limits applicable to award of the Contract.

8. **Disclosure of First Tier Subcontractors.** Bidders must submit a First Tier Subcontractor Disclosure Statement where the bid exceeds \$100,000. The subcontractor disclosure statement may be submitted in the sealed bid prior to the bid closing OR it may be submitted in a separate sealed envelope marked "FIRST TIER SUBCONTRACTOR DISCLOSURE STATEMENT" and the name of the project, within two (2) working hours after the bid closing. Bidder must submit a First Tier Subcontractor Disclosure Statement on the form provided in these contract documents identifying all first-tier subcontractors that will furnish labor or labor and materials and whose contract value is equal to or greater than:

- A. 5% of the total project bid, but at least \$15,000, or
- B. \$350,000 regardless of the percentage of the total project bid.

For each subcontractor listed, Include:

- A. The name of the subcontractor,
- B. The anticipated amount of the subcontract
- C. The category of work that the subcontractor would be performing.

If no subcontracts subject to the above disclosure requirements are anticipated, a bidder is required to indicate "NONE" on the accompanying form.

To determine disclosure requirements, it is required that bidders disclose subcontract information for any subcontractor as follows:

- A. Use the forms bound herewith for the required disclosure.

Notice – Bidder’s Requirements: Bidders are required to disclose information about certain first-tier subcontractors when the contract value for a Public Improvement is greater than \$100,000 (see ORS 279C.370). Specifically, when the contract amount of a first-tier subcontractor furnishing labor or labor and materials would be greater than or equal to: (i) 5% of the project bid, but at least \$15,000, or

(ii) \$350,000 regardless of the percentage, the bidder must disclose the following information about that subcontract either in its Bid submission or within two working hours after bid closing:

- 1) The subcontractor's name,
 - 2) The anticipated amount of the subcontract, and
 - 3) The category of work that the subcontractor would be performing.
- B. If the bidder will not be using any subcontractors that are subject to the above disclosure requirements, the bidder is required to indicate "NONE" on the accompanying form.
- C. Bidder shall submit the disclosure form required by OAR 137-049-0360 either in its bid submission or separately within two working hours after Bid Closing in the manner specified by the invitation to bid.
- D. Compliance with the disclosure and submittal requirements of ORS 279C.370 and OAR 137-049-0360 is a matter of Responsiveness. Bids which are submitted by Bid Closing, but for which the disclosure submittal has not been made by the specified deadline, are not responsive and shall not be considered for Contract award.
- E. County shall obtain, and make available for public inspection, the disclosure forms required by ORS 279C.370 and OAR 137-049-0360. County shall also provide copies of disclosure forms to the Bureau of Labor and Industries as required by ORS 279C.835. County is not required to determine the accuracy or completeness of the information provided on disclosure forms.
- F. Substitution of affected first-tier subcontractors shall be made only in accordance with ORS 279C.585. County shall accept written submissions filed under the statute as public records. Aside from issues involving inadvertent clerical error under ORS 279.585(5), County does not have a statutory role or duty to review, approve, or resolve disputes concerning such substitutions. See ORS 279C.590 regarding complaints to the Construction Contractors Board on improper substitution.

THE COUNTY MUST REJECT A BID IF THE BIDDER FAILS TO SUBMIT THE DISCLOSURE FORM WITH THIS INFORMATION BY THE STATED DEADLINE (see OAR 137-049-0360).

9. **Bid Security.** The Bid Bond or Cashier's Check will be for a minimum of ten per cent (10%) of the amount of the bid price. If a bidder bids more than one bid proposal, each proposal must be accompanied by separate bid security. The County reserves the right to retain the bid security of the three (3) lowest bidders until the successful bidder has signed and delivered the contract and furnished one hundred percent (100%) Performance and Payment Bonds.
10. **Conditions of Work.** Each bidder must inform himself of the conditions relating to the execution of the work, and make himself thoroughly familiar with all the Contract documents. Failure to do so will not relieve the successful bidder of his obligations to enter into a Contract and complete the contemplated work in strict accordance with the Contract documents.

Each bidder must inform himself on all laws and statutes, both Federal and State, relative to the regular execution of the work, the employment of labor, protection of public health, access to the work and similar requirements.

11. **Award of Contract.** The award of the contract will be made by the County on the basis of the proposal which in its sole and absolute judgment will best serve the interest of the County.

County will issue a notice of intent to award contract. Any bidder may protest the notice of intent to award contract within seven (7) calendar days of the notice of intent to award contract.

The County reserves the right to accept or reject any or all proposals, and to waive any informalities and irregularities in said proposals.

12. **Payment and Retainage.** Payment for work performed will be made by the County as specified in the Special Provisions based upon the contract unit prices on the Bid Schedule.

Upon substantial completion of the contract, Contractor may request a partial release of retainage held by the County. The maximum amount of a request for a partial release retainage shall be the Contract amount less 150 percent of the estimated cost of the Contract yet to be performed through final completion. Upon final completion, Contractor may request release of the remaining retainage. Each request for the release of retainage shall be accompanied by the Consent of the contractor's surety.

13. **Performance Bond and Payment Bond.** The successful bidder shall file with the County, at the time of execution of the contract, a Performance Bond and a Payment Bond each of not less than the contract price on the forms furnished by the County. The Surety Company furnishing the required bonds shall have a sound financial standing and a record of service satisfactory to the County, and shall be authorized to do business in the State of Oregon. In lieu of a Performance Bond, the contractor may file cash, a Certified or Cashier's Check made payable to Deschutes County, Oregon. This money, check or certificate will be held by the County conditioned on and subject to the same provisions as set forth in the attached Performance Bond. ORS 279C.380 allows no flexibility for a cash deposit in lieu of a Payment Bond.

County may request a copy of Contractor's surety bond(s). Contractor must supply County with copy of surety bond(s) within ten (10) calendar days from the date of the request.

14. **Required Public Works Bond** The Contractor and every subcontractor must have a public works bond filed with the Construction Contractors Board, 700 Summer St. NE, Suite 300, Salem, Oregon 97309-5052, before starting work on the project, unless except under ORS 279C.836(7) or (8) of 2005 Oregon Laws Chapter 360. Every subcontract to which Contractor is a party for the performance of work under this Contract shall contain a provision requiring the subcontractor to have a public works bond filed with the Construction Contractors Board before starting work on this project, unless exempt under ORS 279C.836 (7) or (8) of 2005 Oregon Laws Chapter 360.

15. **Failure to Execute Contract.** Upon failure by the successful bidder to enter into the Contract and furnish the necessary bond within ten (10) calendar days from the date Notice of Award is made, the bid security accompanying the bid shall be forfeited, the proceeds paid to the County, and the award withdrawn. The award may then be made to the next lowest responsible bidder, or all bids rejected and work is re-advertised.

16. **Disclaimer of Responsibility.** Neither the County nor the Director of Solid Waste will be responsible for oral interpretations. Should a bidder find discrepancies in, or omissions from the drawings, specifications, or other pre-bid documents, or be in doubt as to their meaning, bidder shall notify the County at least seven (7) calendar working days prior to the bid opening date. Any and all such interpretations, any supplemental instructions or approval of manufacturer's materials to be substituted will be made only in the form of written addenda to the specifications, which, if issued, will be hand delivered or sent by regular mail, email and fax to all prospective bidders receiving a set of such documents, not later than two (2) calendar days prior to the date fixed for the opening of bids. Failure of any bidder to receive any such addendum or interpretation shall not relieve such bidder from any obligation under his bid as submitted. All addenda so issued are to be covered in the bid for such addenda to become part of the Contract.

17. **Permits and Licenses.** The successful bidder shall be required to have or obtain, at his expense, any and all permits and licenses required by Deschutes County, any City within the County, and the State of Oregon,

pertaining to the service he proposes to furnish. Licensing shall include without limitation registration with Construction Contractors Board and in the case of professional engineers and architects proof of current licensing with the appropriate State licensing board.

18. **Minimum Requirements of Bid.** The following minimum requirements as to the form and manner of submitting bids must be strictly observed; variance from these requirements will result in rejection of the bid as unresponsive.
- A. Each Bid must be submitted on forms furnished by the County, and include a complete original set of all forms provided in Part V-Bid Proposal Forms of these Contract Documents.
 - B. Each Bid must be signed by the bidder.
 - C. Bid security, in the required form and amount, must accompany each bid.
 - D. Each blank in the proposal must be filled in unless an alternative is provided. Each separate bid item must be bid on, unless the proposal form clearly indicates otherwise.
 - E. Each Bid must be submitted in a separate sealed envelope, marked to identify without opening, and in the hands of the Solid Waste Department Director at the time and place specified for bid opening.
 - F. A proposal containing modifications, deletions, exceptions or reservations which in any way conflict with or purport to alter any substantive provision contained in the bid documents, will not be considered.
 - G. A conditional bid will not be considered.
 - H. Any bid submitted without all of the pages of the bid documents, but with a sufficient number of the pages of the bid documents to allow the evaluation of the bid, shall be deemed to have been submitted with the missing pages for purposes of bid evaluation. The missing pages of the bid documents shall be deemed to be incorporated into bid by reference.
19. **Plans.** Plans are not to be taken or construed as being reproduced at precisely the indicated scale. Where the plans are photographic reductions of the original tracings, the approximate amount of reduction is indicated by a note on the plans.
20. **Specifications.** The specifications are the minimum acceptable specifications for the project for which proposals are sought. Any deviation from the specifications contained herein, shall render the bid non-responsive.
21. **Examination of Site and Conditions.** Bidders are required, prior to submission of bids, to carefully examine the site and the Plans and Specifications of the contemplated work. Errors and omissions in the Plans or Specifications shall be called to the attention of the Solid Waste Department Director prior to submission of bid so that addenda may be issued. Failure to do so on the part of the Contractor does not relieve him of responsibility for a correct and completely finished job. Only a written interpretation or correction by addendum shall be binding.
22. **Pre-Bid Inquiries.** Bidders with pre-bid inquiries shall contact Chad Centola, Deschutes County Solid Waste Department Operations Manager at (541) 322-7172 or chadc@deschutes.org.

23. **Prequalification of Bidders.** Bidders shall be prequalified with the State of Oregon in accordance with ORS 279C.430 – 279C.450 and Deschutes County Code 12.52.0020. The prequalification classification required for this project is “EART-Earthwork and Drainage.” Bidders shall be registered with the Construction Contractor’s Board. Contractors and subcontractors need not be licensed under ORS 468A.720. This contract is subject to ORS 279C.800 to 279C.870. The successful bidders and subcontractors providing labor shall maintain a qualified drug-testing program for the duration of the contract. Bidders shall be registered with the Construction Contractor’s Board. Contractors and subcontractors need not be licensed under ORS 468.710.

The County may make any further investigation deemed necessary to resolve any doubt as to the bidder's qualifications, and the bidder shall furnish to the County all such information and data for this purpose as the County may request. The County reserves the right to reject any bid if the evidence submitted or investigation of such bidder fails to satisfy the County that such bidder is in all respects able to adequately perform the obligations of the Contract and to complete the work contemplated therein.

Any bidder who is disqualified may appeal his disqualification to the Board of County Commissioners of Deschutes County, Oregon, which is the local public contract review board as provided by State Law. Written notice of such appeal must be filed with the Board of County Commissioners by the close of business on the third County business day following the bidder's receipt of notice that he is disqualified.

If a bidder has appealed his disqualification within the time provided, but there has been no disposition of the appeal by the Board of County Commissioners, he may submit his sealed bid on a form marked, "SAMPLE ONLY, NOT TO BE USED FOR BIDDING", and sealed in an envelope marked the same. His bid will not be opened, but will be forwarded to the Board of County Commissioners. If after considering the matter, the Board of County Commissioners determines that the bidder is qualified, the Board shall open and read the bid, and it shall be considered with all other bids. If the bidder is not found qualified after appeal, the bid will be opened, copied and returned to the disqualified bidder. The bid shall not be read publicly, and the Board of County Commissioners action on appeal; or its public disclosure is mandated under the procedure as specified in ORS 192.480 or 192.490.

24. **Contract Award.** Deschutes County reserves the right to postpone award of the contract for fourteen (14) calendar days from the date of the bid opening, or until a final decision is made on a protest, whichever is later.
25. **Bidder Statement.** Submission of a bid for the project shall constitute a statement by the bidder that the provisions of ORS 279C.840 are to be complied with.

PART III – GENERAL CONDITIONS

1. **Prevailing Rates of Wage.** This Contract is subject to the “Prevailing Wage Rates for Public Works Contracts in Oregon” as published by the Oregon Bureau of Labor and Industries (dated January 1, 2016), and, if applicable the Federal Prevailing Rate of Wage required under the Davis-Bacon Act (40 U.S.C. 3141 et seq.) that may be paid to workers in each trade or occupation required for the public works employed in the performance of the contract either by the contractor or subcontractor or other person doing or contracting to do the whole or any part of the work contemplated by the contract. The following internet link may be used to obtain the access to State and Federal Prevailing Wage Rates:

http://www.oregon.gov/BOLI/WHD/PWR/pwr_book.shtml

2. **Required Conditions in Public Works Contract and Contract Specifications - ORS 279C.800 to 279C.870.** County shall pay to the Bureau of Labor and Industries a fee equal to one tenth of one percent (.001) of the contract price but no less than \$250 nor more than \$7,500 regardless of the contract price; that the fee shall be paid no later than the date the contract is signed; and that the fee shall be delivered to the Bureau at the following address: Prevailing Wage Rate Unit, Wage and Hour Division, Bureau of Labor and Industries, 800 NE Oregon Street #32, Portland, OR 97232.

Posting Requirements. Contractors shall post the prevailing wage rates applicable to the project in a conspicuous place at the site of work. The posting shall be easily accessible to employees working on the project.

When a contractor or subcontractor provides for or contributes to a health and welfare plan or pension plan for employees who are working on a public works project, the contractor or subcontractor shall post a notice containing the following information:

- A. A description of the plan or plans;
- B. Information on how and where claims can be made; and,
- C. Where to obtain more information

All required postings shall be posted in the same place and shall be in a conspicuous place at the site of work and shall be easily accessible to employees working on the project.

3. **Required Payroll Submissions.** Contractors and subcontractors on public works projects are required to prepare **weekly** certified payroll reports and statements and submit them to the public contracting agency by the fifth business day of each month. Contractors and subcontractors who fail to submit certified payroll reports as described above, will be subject to a twenty five percent (25%) withholding of the amounts owed by the County.

Information submitted on certified statements may be used only to ensure compliance with the provisions of ORS 279C.800 to 279C.870. These are public records and must be made available on request. Contractors may submit their own report as long as it contains all the same information as the WH-38 form (see Prevailing Wage Rates published by the Oregon Bureau of Labor and Industries for forms). Contractors must complete the statement of certification and attach it to the payroll submissions.

4. **Contracting Agency Payments.** If the Contractor fails, neglects, or refuses to make prompt payment of any claim for labor or services furnished to the Contractor or Subcontractor by any person, or the assignee of the person, in connection with the public works contract as such claim becomes due, the proper officer or officers

of the public contracting agency may pay such claim and charge the amount of the payment against funds due or to become due the Contractor by reason of the Contract.

5. **Interest Rate For Failure to Make Payment.** If Contractor or a first-tier subcontractor fails, neglects or refuses to make payment to a person furnishing labor or materials in connection with this contract for a public improvement within 30 days after receipt of payment from the County or a Contractor, the Contractor or first-tier subcontractor shall owe the person the amount due plus interest charges commencing at the end of the 10-day period that payment is due under ORS 279C.580(4) and ending upon final payment, unless payment is subject to a good faith dispute as defined in ORS 279C.580. The rate of interest charged to the Contractor or first-tier subcontractor on the amount due shall equal three times the discount rate on 90-day commercial paper in effect at the Federal Reserve Bank in the Federal Reserve district that includes Oregon on the date that is 30 days after the date when payment was received from the County or from the Contractor, but the rate of interest shall not exceed 30 percent. The amount of interest may not be waived.
6. **Construction Contractors Board Complaint.** If Contractor or a subcontractor fails, neglects or refuses to make payment to a person furnishing labor or materials in connection with this contract, the person may file a complaint with the Construction Contractors Board, unless payment is subject to a good faith dispute as defined in ORS 279C.580.
7. **Independent Contractor.** Contractor is engaged hereby as an independent contractor, and will be so deemed for purposes of the following:
 - A. Contractor will be solely responsible for payment of any Federal or State taxes required as a result of this Agreement.
 - B. This Contract is not intended to entitle Contractor to any benefits generally granted to County employees. Without limitation, but by way of illustration, the benefits which are not intended to be extended by this Contract to the Contractor are vacation, holiday and sick leave, other leaves with pay, tenure, medical and dental coverage, life and disability insurance, overtime, Social Security, Workers' Compensation, unemployment compensation, or retirement benefits (except insofar as benefits are otherwise required by law if the Contractor is presently a member of the Public Employees Retirement System).
 - C. Contractor is an independent contractor for purposes of the Oregon Workers' Compensation law (ORS Chapter 656) and is solely liable for any Workers' Compensation coverage under this Contract. If Contractor has the assistance of other persons in the performance of this Contract, the Contractor shall qualify and remain qualified for the term of this Contract as a direct responsibility employer under ORS 656.407, and furnish County with evidence of said insurance. If Contractor performs this contract without the assistance of any other person, Contractor shall execute a Joint Declaration with County's Workers' Compensation carrier absolving County of any and all liability from Workers' Compensation provided in ORS 656.029 (2).
8. **Delegation and Reports.** Contractor shall not delegate the responsibility for providing services hereunder to any other individual or agency, and shall provide County with periodic reports to County at the frequency and with the information prescribed to be reported by County.
9. **Constraints.** Pursuant to the requirements of ORS 279C.500 through 279C.540 and Article XI, Section 10, of the Oregon Constitution, the following terms and conditions are made a part of this Agreement:
 - A. Contractor shall:
 - 1) Make all payments promptly, as due, to all persons supplying to Contractors labor or materials for the prosecution of the work provided for in this agreement.

- 2) Pay all contributions or amounts due the Industrial Accident Fund from such contractor or subcontractor incurred in the performance of this Agreement.
 - 3) Not permit any lien or claim to be filed or prosecuted against County on account of any labor or material furnished.
 - 4) Not permit any lien or claim to be filed or prosecuted against County on account of any labor or material furnished.
 - 5) Pay to the Department of Revenue all sums withheld from employees pursuant to ORS 316.167.
 - 6) Demonstrate that an employee drug testing program is in place prior to execution of this Contract.
- B. If Contractor fails, neglects or refuses to make prompt payment of any claim for labor or services furnished to Contractor or a subcontractor by any person in connection with this agreement as such claim becomes due, the proper officers representing County may pay such claim to the person furnishing the labor or services and charge the amount of the payment against funds due or to become due Contractor by reason of this agreement.
- C. Employees of Contractor shall be paid at least time and a half for all overtime worked in excess of eight hours a day or forty (40) hours in any one week when the work week is five consecutive days, Monday through Friday; or for all overtime in excess of 10 hours a day or 40 hours in any one week when the work week is four consecutive days, Monday through Friday, except individuals under this contract who are excluded under ORS 653.010 to 653.261 or under 29 U.S.C. Sections 201 to 209 from receiving overtime.
- D. Employees of Contractor providing labor shall be paid at least time and a half for all work performed on Saturday and Sunday and the following legal holidays:
- 1) New Year's Day on January 1.
 - 2) Memorial Day on the last Monday in May.
 - 3) Independence Day on July 4.
 - 4) Labor Day on the first Monday in September.
 - 5) Thanksgiving Day on the fourth Thursday in November.
 - 6) Christmas Day on December 25.
- E. An employer must give notice to employees who perform work under this agreement in writing, either at the time of hire or before commencement of work on the contract, or by posting a notice in a location frequented by employees, of the number of hours per day and days per week that employees may be required to work.
- F. An employer must give notice to employees who perform work under this agreement in writing, either at the time of hire or before commencement of work on the contract, or by posting a notice in a location frequented by employees, of the number of hours per day and days per week that employees may be required to work.
- G. Contractor shall promptly, as due, make payment to any person or partnership, association or corporation furnishing medical, surgical and hospital care or other needed care and attention incident to sickness and/or injury to the employees of Contractor, of all sums which Contractor agrees to pay for such services, and all monies and sums which Contractor collected or deducted from the wages of Contractor's employees pursuant to any law, contract or agreement for the purpose of providing or paying for such services.
- H. This Agreement is expressly subject to the debt limitation of Oregon counties set forth in Article XI, Section 10, of the Oregon Constitution, and is contingent upon funds being appropriated therefore. Any provision herein which would conflict with law are deemed inoperative to that extent.
- I. All subject employers working under this contract are either employers that will comply with ORS 656.017 or are employers that are exempt under ORS 656.126

10. Early Termination. This Contract may be terminated as follows:

- A. Mutual Consent. County and Contractor, by mutual written agreement, may terminate this Contract at any time.
- B. Party's Convenience. County or Contractor may terminate this Contract for any reason upon 30 calendar days written notice to the other party.
- C. For Cause. County may also terminate this Contract effective upon delivery of written notice to the Contractor, or at such later date as may be established by the County, under any of the following conditions:
 - 1) If funding from state or other sources is not obtained and continued at levels sufficient to allow for the purchase of the indicated quantity of services as required in this contract. This Contract may be modified to accommodate the change in available funds.
 - 2) If state laws, regulations or guidelines are modified, changed or interpreted in such a way that the services are no longer allowable or appropriate for purchase under this Contract or are no longer eligible for the funding proposed for payments authorized by this contract.
 - 3) In the event sufficient funds shall not be appropriated for the payment of consideration required to be paid under this contract, and if County has no funds legally available for consideration from other sources.
 - 4) If any license or certificate required by law or regulation to be held by the Contractor to provide the services required by this Contract is for any reason denied, revoked, suspended, not renewed or changed in such a way that the Contractor no longer meets requirements for such license or certificate.
- D. Contractor Default or Breach. The County, by written notice to the Contractor, may immediately terminate the whole or any part of this Contract under any of the following conditions:
 - 1) If the Contractor fails to provide services called for by this Contract within the time specified or any extension thereof.
 - 2) If the Contractor fails to perform any of the other requirements of this Contract or so fails to pursue the work so as to endanger performance of this Contract in accordance with its terms, and after receipt of written notice from the County specifying such failure, the Contractor fails to correct such failure within 10 calendar days or such other period as the County may authorize.
 - 3) Contractor institutes or has instituted against it insolvency, receivership or bankruptcy proceedings, makes an assignment for the benefit of creditors, or ceases doing business on a regular basis.
- E. County Default or Breach. Contractor may terminate this Contract in the event of a breach of this Contract by the County. Prior to such termination, the Contractor shall give to the County written notice of the breach and intent to terminate. If the County has not entirely cured the breach within 10 calendar days of the date of the notice, then the Contractor may terminate this Contract at any time thereafter by giving notice of termination.

11. Payment on Early Termination. Upon termination pursuant to paragraph 10, payment shall be made as follows:

- A. If terminated under subparagraphs 10 a. through c. of this Contract, the County shall pay Contractor for work performed prior to the termination date if such work was performed in accordance with the Contract. County shall not, however, pay Contractor for any obligations or liabilities incurred by Contractor after Contractor receives written notice of termination.
- B. If this Contract is terminated under subparagraph 10 d. of this Contract, County obligations shall be limited to payment for services provided in accordance with this Contract prior to the date of termination, less any damages suffered by the County.
- C. If terminated under subparagraph 10 e. of this Contract by the Contractor due to a breach by the County, then the County shall pay the Contractor for work performed prior to the termination date if such work was

performed in accordance with the Contract (a) with respect to services compensable on an hourly basis, for unpaid invoices, hours worked within any limits set forth in this Contract but not yet billed, authorized expenses incurred and interest within the limits set forth under ORS 293.462, and (b) with respect to deliverable-based Work, the sum designated for completing the deliverable multiplied by the percentage of Work completed and accepted by County, less previous amounts paid and any claim(s) that County has against Contractor. In no event shall County be liable to Contractor for any expenses related to termination of this Contract or for anticipated profits.

12. Remedies. In the event of breach of this Contract the parties shall have the following remedies:

- A. Termination under subparagraphs 10 a. through c. of this Contract shall be without prejudice to any obligations or liabilities of either party already reasonably incurred prior to such termination. Contractor may not incur obligations or liabilities after Contractor receives written notice of termination. Additionally, neither party shall be liable for any indirect, incidental, consequential or special damages under this Contract or for any damages of any sort arising solely from the termination of this Contract in accordance with its terms.
- B. If terminated under subparagraph 10 d. of this Contract by the County due to a breach by the Contractor, County may pursue any remedies available at law or in equity. Such remedies may include, but are not limited to, termination of this contract, return of all or a portion of this Contract amount, payment of interest earned on this Contract amount, and declaration of ineligibility for the receipt of future contract awards. Additionally, County may complete the work either itself, by agreement with another Contractor, or by a combination thereof. If the cost of completing the work exceeds the remaining unpaid balance of the total compensation provided under this Contract, then the Contractor shall pay to the County the amount of the reasonable excess.
- C. In addition to the remedies in paragraphs 10 through 12 of this Contract for a breach by the Contractor, the County also shall be entitled to any other equitable and legal remedies that are provided by law.
- D. If previous amounts paid to Contractor exceed the amount due to Contractor under this Contract, Contractor shall repay any excess to County upon demand.
- E. If the County breaches this Contract, Contractor's sole monetary remedy shall be (a) with respect to services compensable on an hourly basis, a claim for unpaid invoices, hours worked within any limits set forth in this Contract but not yet billed, authorized expenses incurred and interest within the limits set forth under ORS 293.462, and (b) with respect to deliverable-based Work, a claim for the sum designated for completing the deliverable multiplied by the percentage of Work completed and accepted by County, less previous amounts paid and any claim(s) that County has against Contractor. In no event shall County be liable to Contractor for any expenses related to termination of this Contract or for anticipated profits.
- F. Neither County nor Contractor shall be held responsible for delay or default caused by fire, civil unrest, labor unrest, riot, acts of God, or war where such cause was beyond reasonable control of County or Contractor, respectively. Contractor shall, however, make all reasonable efforts to remove or eliminate such a cause of delay or default and shall, upon the cessation of the cause, diligently pursue performance of its obligations under this Contract. For any delay in performance as a result of the events described in this subparagraph, Contractor shall be entitled to additional reasonable time for performance that shall be set forth in an amendment to this Contract.
- G. The passage of this Contract expiration date shall not extinguish or prejudice the County's or Contractor's right to enforce this Contract with respect to any default or defect in performance that has not been cured.
- H. **LIQUIDATED DAMAGES.** It is impractical to determine the actual damages that the County would sustain in the event the project is not completed within seventy-five (75) calendar days after receipt of Notice to

Proceed. Therefore, the Contractor shall pay to the County, not as a penalty, but as liquidated damages, **\$500 per calendar day**, or any portion thereof, for each day in which the project is not completed by such date.

- I. County's remedies are cumulative to the extent the remedies are not inconsistent, and County may pursue any remedy or remedies singly, collectively, successively or in any order whatsoever.

13. **Contractor's Tender Upon Termination.** Upon receiving a notice of termination of this Contract, Contractor shall immediately cease all activities under this Contract unless County expressly directs otherwise in such notice of termination. Upon termination of this Contract, Contractor shall deliver to County all documents, information, works-in-progress and other property that are or would be deliverables had this Contract been completed. Upon County's request, Contractor shall surrender to anyone County designates, all documents, research, objects or other tangible things needed to complete the work.
14. **Work Standard.** Contractor shall be solely responsible for and shall have control over the means, methods, techniques, sequences and procedures of performing the work, subject to the plans and specifications under this Contract and shall be solely responsible for the errors and omissions of its employees, subcontractors and agents. For goods and services to be provided under this contract, Contractor agrees to:
 - A. Perform the work in a good, workmanlike, and timely manner using the schedule, materials, plans and specifications approved by County;
 - B. Comply with all applicable legal requirements;
 - C. Comply with all programs, directives, and instructions of County relating to safety, storage of equipment or materials;
 - D. Take all precautions necessary to protect the safety of all persons at or near County or Contractor's facilities, including employees of Contractor, County and any other contractors or subcontractors and to protect the work and all other property against damage.
15. **Hold Harmless.** To the fullest extent allowed by law Contractor shall indemnify, save harmless and defend the County from and against all claims, suits or actions for damages, costs, losses and expenses arising from Contractor's torts, as the term "tort" is defined in ORS 30.260(8).
16. **Contractor Not An Agent of County.** It is agreed by and between the parties that Contractor is not carrying out a function on behalf of County, and County does not have the right of direction or control of the manner in which Contractor delivers services under this agreement or exercise any control over the activities of Contractor.
17. **Partnership.** County is not, by virtue of this Contract, a partner or joint venturer with Contractor in connection with activities carried out under this Contract, and shall have no obligation with respect to Contractor's debts or any other liabilities of each and every nature.
18. **Insurance.** In conjunction with all services performed under this agreement: Contractor shall furnish proof of the types and amounts of insurance indicated in Part VI, Agreement Forms, attached hereto and by this reference incorporated herein. County reserves the right to require completed, certified copies of all required insurance policies, at any time.
19. **Non-Discrimination.** Contractor agrees that no person shall, on the grounds of race, color, creed, national origin, sex, marital status, or age, suffer discrimination in the performance of this Agreement when employed by Contractor. Contractor agrees to comply with Title VI of the Civil Rights Act of 1964, with Section V of the Rehabilitation Act of 1973, and with all applicable requirements of federal and state civil rights and

rehabilitation statutes, rules and regulations. Additionally, each party shall comply with the Americans with Disabilities Act of 1990 (Pub. L. No. 101-336), ORS 659A.112, and all regulations and administrative rules established pursuant to those laws.

20. **Non-Appropriation.** In the event sufficient funds shall not be appropriated for the payment of consideration required to be paid under the Contract, and if County has no funds legally available for consideration from other sources, then County may terminate this agreement in accordance with Paragraph 10 of these General Conditions.
21. **Attorney Fees.** In the event an action, lawsuit or proceeding, including appeal there from, is brought for failure to observe any of the terms of this Agreement, each party shall be responsible for their own attorney's fees, expenses, costs and disbursements for said action, suit, proceeding or appeal.
22. **Claim, Action, Suit or Proceeding.** This Contract shall be governed by and construed in accordance with the laws of the State of Oregon without regard to principles of conflicts of law. Any claim, action, suit or proceeding (collectively, "Claim") between County and Contractor that arises from or relates to this Contract shall be brought and conducted solely and exclusively within the Circuit Court of Deschutes County for the State of Oregon; provided, however, if a Claim must be brought in a federal forum, then it shall be brought and conducted solely and exclusively within the United States District Court for the District of Oregon. **THE RECIPIENT, BY EXECUTION OF THIS CONTRACT, HEREBY CONSENTS TO THE IN PERSONAM JURISDICTION OF SAID COURTS.**
23. **Land Use Permit.** This contract does not constitute a land use permit, nor does acceptance of this Contract by Contractor constitute approval of any legislative or quasi-judicial action required as a condition precedent to use of the land for the intended purpose.
24. **Drug Testing Program.** The drug testing program in place at execution of this Contract shall remain in place for the duration of the Contract.
25. **Records Maintenance; Right to Audit Records.**
 - A. **Records Maintenance; Access.** Contractors and subcontractors shall maintain all fiscal records relating to Contracts in accordance with generally accepted accounting principles ("GAAP"). In addition, Contractors and subcontractors shall maintain all other records necessary to clearly document:
 - 1) Their performance; and
 - 2) Any claims arising from or relating to their performance under this Contract. Contractors and subcontractors shall make all records pertaining to their performance and any claims under a Contract (the books, fiscal records and all other records, hereafter referred to as "Records") accessible to the County at reasonable times and places, whether or not litigation has been filed as to such claims.
 - B. **Inspection and Audit.** County may, at reasonable times and places, have access to and an opportunity to inspect, examine, copy, and audit the Records of any Entity that has submitted cost or pricing data according to the terms of a Contract to the extent that the Records relate to such cost or pricing data. If the Entity must provide cost or pricing data under a Contract, the Entity shall maintain such records that relate to the cost or pricing data for 3 years from the date of final payment under the Contract, unless a shorter period is otherwise authorized in writing.
 - C. **Records Inspection; Control Audit.** County, and its authorized representatives, shall be entitled to inspect, examine, copy, and audit any Contractor's or subcontractor's Records, as provided in Section A of this rule. The Contractor and subcontractor shall maintain the Records and keep the Records accessible and available at reasonable times and places for a minimum period of 3 years from the date of final payment under the Contract or subcontract, as applicable, or until the conclusion of any audit, controversy or litigation arising out of or related to the Contract, whichever date is later, unless a shorter period is otherwise authorized in writing.

26. **Contract Rules.** The rules applicable to this contract are the Attorney General’s Model Public Contract Rules, Chapter 137-046 and Chapter 137-049, as presently constituted and Deschutes County Code (DCC) Chapter 2.37. The provisions of DCC Chapter 2.37.150 are incorporated herein by reference. These provisions may be viewed at the following web address: <http://www.co.deschutes.or.us/dccode/Title2/docs/Chapter%202.37doc>
27. **Contractor Certifies.** By execution of this contract, Contractor certifies, under penalty of perjury, that:
- A. To the best of Contractor’s knowledge, Contractor is not in violation of any tax laws described in ORS 305.380(4), and
 - B. Contractor has not discriminated against minority, women or small business enterprises in obtaining any required subcontracts.
28. **Contract Provisions.** Contractor shall make all provisions of this contract with the County applicable to any subcontractor performing work under the contract.
29. **Contract Content.** This Contract and attached exhibits and attachments constitute the entire agreement between the parties on the subject matter hereof. There are no understandings, agreements, or representations, oral or written, not specified herein regarding this Contract. No waiver, consent, modification or change of terms of this Contract shall bind either party unless in writing and signed by both parties and all necessary County approvals have been obtained. Such waiver, consent, modification or change, if made, shall be effective only in the specific instance and for the specific purpose given. The failure of the County to enforce any provision of this Contract shall not constitute a waiver by County of that or any other provision.
30. **Hazardous Materials.** Contractor shall not generate, store, process, dispose, release or discharge into the environment any hazardous, toxic, radioactive, or other dangerous materials on or about the work site subject to this Contract, nor allow any of its subcontractors to engage in such prohibited activities. Contractor agrees to indemnify, defend and hold the County, its officer, agents, and employees harmless from and against any and all claims, suits, actions, demands, damages, costs, losses and expenses in any manner resulting from, arising out of, or connected with any such prohibited activities of Contractor or its subcontractors. Discovery by Contractor of unanticipated hazardous, toxic, radioactive or other dangerous materials present at the work site shall not constitute a release or discharge by Contractor.

County and Contractor agree that, Contractor’s discovery of unanticipated hazardous, toxic, radioactive, or other dangerous materials constitutes a changed condition mandating re-negotiation of the scope of work to be performed by Contractor, the terms under which the work is to be performed, and the charges therefore. Except as otherwise specified in this paragraph, nothing contained in this Contract shall be construed or interpreted as requiring Contractor to assume the status of an owner, operator, or generator, under any federal or state statute governing the disposal, transportation, storage or treatment of hazardous substances or wastes. Contractor shall not directly or indirectly assume title to such hazardous or toxic substances. Should the proper and lawful transportation and disposal of any such materials be required, Contractor’s responsibilities shall be limited to facilitating the preparation of manifests or related documents for execution by County for the proper disposal, storage or treatment of such materials. In the event such materials are discovered at the work sites by County, Contractor or any of their employees, subcontractors or agents, County shall have the option to terminate this Contract pursuant to paragraph 19 herein. Contractor shall have an affirmative duty to disclose and immediately notify County upon discovery or knowledge of the existence of any such materials at the work site.

PART IV – SPECIAL PROVISIONS

Division 1: General Requirements

Section 01010 - Summary of the Work

A. General Statement and Extent of Work. The work to be performed under these Contract Documents consists of furnishing all labor, materials, tools, and equipment necessary for the clearing and grubbing, fill excavation, embankment placement and grading, placement and grading of finished surface, installation of water service facilities, installation of electrical service facilities and other items of work specified. The project site is at Knott Landfill located at 61050 SE 27th Street in Deschutes County, Oregon.

The work shall be performed in a workmanlike manner, complete and usable as required by the drawings and these specifications. The work is to be constructed for Deschutes County, herein referred to as the Owner.

B. Drawings for Construction. Drawings for this project are shown on the contract drawings attached to these Contract Documents.

C. Time of Completion and Liquidated Damages. Performance of the work to be done under the Contract shall be commenced within ten (10) calendar days after receipt of written notice to proceed by the Contractor, unless later commencement of the work is authorized by the Owner. The Contractor shall complete all work items contained within the Contract Documents within seventy-five (75) calendar days after receipt of the written notice to proceed. For each calendar day after this date that the work remains uncompleted, the Contractor shall pay to the Owner five hundred dollars (\$500.00) per calendar day as liquidated damages. Such amounts shall be a reimbursement to the Owner for damages which the Owner will have sustained by reason of such delayed completion. Contractor and Owner agree that the actual amount of damages for delay that will be sustained are difficult to ascertain and, therefore, the amount set forth herein is the best estimate of the amount of damages sustained by Owner as a result of Contractor's failure to complete the performance of the work with the time allowed herein. Damages so liquidated are understood to include the additional cost to the Owner for interference with landfill operations, Owner supervision, observation of construction, interest charges and overhead.

E. Project Coordination. It shall be the responsibility of the Contractor to coordinate all work to be performed under this Contract. This coordination shall encompass all work to be performed by the Contractor, Contractor's subcontractors, the Owner, and any public utilities which may be involved.

F. Access to the Work. The Contractor shall provide access to the work as may be required by the Owner or its duly authorized representatives. The Contractor also shall provide access to the work for representatives of local, state, and federal agencies as may be required for inspection of the progress of the work, the methods of construction, and for any other aspect of the work or the Contractor's operation under the jurisdiction of the respective agency.

G. Hours of Work. Unless approved otherwise by the owner, all work shall take place Monday through Friday between the hours of 7:00 a.m. and 5:00 p.m.

Section 01040 - Technical Specifications

A. General Statement. Articles, materials, operations or methods mentioned in these Special Provisions, or indicated on the Drawings as being required for the project, shall be provided by the Contractor, and Contractor shall provide each item mentioned or indicated, perform according to the conditions stated in each operation prescribed, and provide, therefore, all necessary labor, materials, tools, equipment, and incidentals necessary to make a complete and operable installation.

No attempt has been made in these Contract Documents to segregate work covered by any trade or subcontract under one specification. Such segregation and establishment of subcontract limits will be solely a matter of specific agreement between the Contractor and Contractor's subcontractors. The Contractor and subcontractor in each case is cautioned that work included in any subcontract may be divided between several general specifications, and that each general specification or subheading of the Special Provisions may include work covered by two or more subcontracts or work in excess of any one subcontract.

B. Standard Specifications. The "Oregon Standard Specifications for Construction," 2015 Edition, prepared by the Oregon Department of Transportation, State Highway Division, and amendments thereto are hereby made a part of this Contract Document and shall be referred to as the "ODOT Standard Specifications". The ODOT Standard Specifications requirements for measurement and payment are not applicable to this project.

Should a conflict occur between the General and Special Provisions as contained herein and those of the ODOT Standard Specifications, the General and Special Provisions shall have precedence.

Where the term "Commission", "Department", "Division", or "Oregon Transportation Commission" appears in the ODOT Standard Specifications, it shall be interpreted to mean the Deschutes County Department of Solid Waste.

Where the term "Owner" appears in the ODOT Standard Specifications, it shall be interpreted to mean Deschutes County Department of Solid Waste directly or acting through its duly authorized representatives.

Where the term "State" appears in the ODOT Standard Specifications, it shall be interpreted to mean Deschutes County acting through authorized representatives.

Section 01042 - Restoration of Improvements

A. Roads and Streets. The Contractor shall restore all roads and streets in which the surface is removed, broken or damaged, or in which the ground has caved or settled, due to the performance of work covered by this Contract, to the original grade and cross section unless otherwise indicated. The Contractor shall match the existing surfacing for depth, materials and surface finish, including striping and pavement markings, except as otherwise specified.

Equipment shall be routed to preclude pumping and/or subgrade damage to on site haul roads. Haul routes proposed by the Contractor will subject to review and approval of the Owner. Where, in the opinion of the Owner, pumping and wearing have progressed to an extent where damage to subgrade has occurred as evidenced by distortion of surface, rutting, or appearance at the surface of

underlying undesiccated soils, the Contractor shall perform subgrade repair at no additional cost to the Owner. If continued hauling causes the loss of stability as evidenced by pumping, or rutting, or other damage to haul routes, the Contractor shall repair the damaged area(s) at his own expense, and adjust his hauling equipment and procedures to avoid further damage.

B. Fencing and Pavement. The Contractor shall reconstruct all fencing, pavement and similar structures which are removed for construction or broken or damaged during construction. The Contractor shall reconstruct with the same kind of material with the same finish, and in not less than the same dimensions as the original work. The Contractor shall match the appearance of the existing improvements as nearly as possible, except as otherwise required.

C. Landfill Environmental Systems. The Contractor shall repair/restore all landfill environmental system components (groundwater monitoring, landfill gas management, leachate management, and landfill liner systems) which are damaged by Contractor activities. In the event of damage to landfill environmental systems, repair work shall be of the utmost priority for immediate restoration.

The Contractor shall employ qualified professional engineering services for any Oregon Department of Environmental Quality required documentation, including, but not limited to repair workplans, quality assurance/quality control plans, and final repair certification reports.

The Contractor shall employ qualified professional contractor services for repairs to damage caused by Contractor activities. Any landfill liner system repair work shall be performed by a qualified landfill liner installer who has installed a minimum of 15,000,000 square feet of certified solid waste landfill liner installation within the past five (5) years.

D. Measurement and Payment. No separate or additional payment will be made for restoration of improvements performed by the Contractor, but shall be considered incidental to the work and shall be included in various unit or lump sum bid items.

Section 01045 - Cooperation with the County, the Public and Other Contractors

A. General. Knott Landfill Recycling and Transfer Facility and Knott Landfill will be operating during this project. The Contractor will not be allowed to work in the active areas of the site being used for waste handling, waste disposal and recycling operations. The Contractor must not restrict access for the Owner and facility users to those areas of the facilities being used for waste handling, waste disposal and recycling operations. The Contractor may construct and maintain detour routes approved by the Owner to areas of the facility as necessary for Contractor's convenience, at no additional cost to the Owner. The Contractor shall submit shop drawing(s) showing proposed detour route(s) including traffic control.

The Contractor shall extend full cooperation to the County, other contractors, and the public. The Contractor shall schedule and construct his work in conjunction with these and other organizations to minimize mutual interference.

B. Payment. No separate or additional payment will be made for cooperation with the County, the public, and other contractors, but shall be considered incidental to the work and shall be included in various unit or lump sum bid items.

Section 01050 – Surveying

A. General. The Contractor shall verify all grades, lines, levels and dimensions shown on the Drawings and shall report any errors or inconsistencies to the Owner before commencing work. Failure to do so shall make the Contractor responsible for any changes which may be required thereafter in connection therewith. The Contractor shall, at Contractor's expense, furnish all stakes, templates, platforms, equipment, and labor that may be required in setting or laying out any part of the work.

The Contractor will be held responsible for the proper execution of the work to such lines and grades as shown on the Drawings and as may be directed by the Owner. All stakes or other marks thus established shall be preserved by Contractor until their removal is authorized by the Owner.

Existing Conditions Drawings show approximate elevations as of February, 2016. Any additional surveying to verify quantities shall be at Contractor expense.

B. Measurements and Payment. No separate or additional payment will be made for surveying arrange by or performed by the Contractor, but shall be considered incidental to the work and shall be included in various unit or lump sum bid items.

Section 01060 – Compliance with Codes, Permits and Prevention of Environmental Degradation

A. General. Environmental degradation control shall consist of the protection of the environment from degradation during and as a result of construction operations under the Contract. The control of environmental degradation requires the consideration of air, water and land and involves noise, dust, and other pollutants. It is the responsibility of the Contractor to investigate and comply with all applicable federal, state, and county laws, regulations, codes and permits concerning environmental pollution control and abatement.

B. Protection of Land Resources. Land resources within the project area and outside the limits of permanent work performed under the Contract shall be preserved in their present condition or be restored to a natural condition that will not detract from the appearance of the surrounding area. Except in areas marked on the Drawings to be cleared, the Contractor shall not deface, injure or destroy trees or shrubs nor remove or cut them without approval by the Owner. Any tree or other landscape feature scarred or damaged by the Contractor's equipment or operation shall be restored as nearly as possible to its original condition at the Contractor's expense.

C. Water Pollution. The Contractor shall not pollute water resources, including streams and drainage systems, with fuel, oils, bituminous materials, calcium chloride, acids, construction wastes, wash waters or other harmful materials. Surface drainage from cuts and fills, whether or not completed, and from borrow and waste disposal areas, shall, if turbidity-producing materials are present, be held in suitable sedimentation ponds or shall be graded to control erosion to meet acceptable limits. Objectionable construction discharges shall be processed, filtered, ponded or otherwise treated prior to their discharge into a waterway or drainage system. Disposal of any material, garbage, oil, grease, chemicals, trash and other similar materials in areas adjacent to streams or drainage systems is prohibited.

D. Protection of Fish and Wildlife. The Contractor shall at all times perform all work and take such steps to prevent any interference or disturbance to fish and wildlife.

E. Permits. Contractor shall be responsible for obtaining all permits necessary for completing the work.

F. Dust Control. The Contractor shall maintain all work within or adjoining the project site free from dust which would cause a hazard or nuisance. Water application or similar methods will be necessary to control dust. Water application shall be repeated at such intervals as to keep all pavements and disturbed areas at least damp enough to prevent dust nuisance at all times, and the Contractor shall have suitable and sufficient equipment on the job at all times to accomplish this work.

Before any work commences under this Contract, if requested by the Owner, the Contractor shall submit to the Owner, for review, a dust control plan to be enforced for the duration of the project. The plan will outline and describe the steps which will be taken to prevent unacceptable dust conditions from being caused by Contractor operations, including operations on any unpaved road, excavation or fill area.

The Contractor shall pay for and shall construct any facilities necessary to furnish water for Contractor's use during construction. Water is available at two (2) hydrant locations adjacent to the project area. If Contractor elects to use these hydrants, the Contractor shall make the appropriate arrangements with Avion Water Company for use. Water used for human consumption shall be kept free from contamination and shall conform to the requirements of the State and local health requirements for potable water.

G. Subcontractors. Compliance with the provisions of this section by the subcontractors will be the responsibility of the Contractor.

H. Non-Compliance. The Owner will notify the Contractor of any non-compliance with the foregoing provisions and the action to be taken. If the Contractor fails or refuses to comply promptly, the Owner may issue an order stopping all or part of the work until satisfactory corrective action has been taken. No extension of time or payment for excess costs or damage shall be made to the Contractor for the time lost due to such stop action. Failure to notify does not change the requirements.

I. Payment. No separate or additional payment will be made for compliance with codes, permits and prevention of environmental degradation, but shall be considered incidental to the work and shall be included in various unit or lump sum bid items.

Section 01070 - Safety Provisions

A. General. Contractor shall comply with all health and safety rules, regulations, and ordinances promulgated by the local, state, and federal governments, the various construction permits, and other sections of the Contract Documents. Such compliance shall include, but not be specifically limited to, any and all protective devices, guards, restraints, locks, latches, switches, and other safety provisions that may be required or necessitated by state and federal safety regulations. The

Contractor shall determine the specific requirements for safety provisions and shall cause inspections and reports by the appropriate safety authorities to be conducted to insure compliance with the intent of the regulations.

Contractor shall perform whatever work is necessary for safety and be solely and completely responsible for conditions of the job site, including safety of all persons (including employees of the Owner and Contractor) and property on the project site during the contract period. Contractor shall provide at all times proper facilities for safe access to the work by authorized government officials. This requirement applies continuously and is not limited to normal working hours.

The Owner's review of the Contractor's performance does not include a review or approval of the adequacy of the Contractor's safety supervisor, safety plans or programs, or any safety measures taken in, on, or near the construction site.

Accidents causing death, injuries, or damage must be reported to the Owner immediately in person or by telephone or messenger. In addition, Contractor shall promptly report in writing to the Owner all accidents whatsoever arising out of, or in connection with, the performance of the work whether on, or adjacent to, the site, giving full details and statements of witnesses.

If a claim is made by anyone against the Contractor or any subcontractor on account of any accident, the Contractor shall promptly report the facts in writing within twenty-four (24) hours after occurrence, to the Owner, giving full details of the claim.

B. Landfill Safety Consideration. The Contractor is advised that the work for this project will be performed adjacent to an active solid waste landfill with buried wastes. These buried wastes decompose in the landfill, generating landfill gas typically composed of carbon dioxide (CO₂), methane (CH₄), hydrogen sulfide (H₂S), and other gases dependent on the composition of the buried wastes. These gases may migrate laterally away from the landfill or vent through the landfill surface.

Some of the hazards associated with landfill areas include, but are not limited to:

- Fires which may start spontaneously from exposed or decomposing waste.
- Fires or explosions which may occur from the presence of methane gas.
- Landfill gases which may cause an oxygen deficiency in trenches, borings, manholes, catch basins, and other structures.
- Landfill gases that may cause acute toxic effects (e.g., H₂S).
- Possible caving of trenches and excavations when working over or in waste fills.
- Biological pathogens or other vectors.

Contractor shall provide for the protection of employees and others from fire, explosion, or exposure and asphyxiation caused by any gases encountered during construction and from landfill gas and leachate emitted from, and present within, the existing solid waste landfill.

Contractor shall inform employees and subcontractors and their employees of the potential danger of working on and near landfills.

C. Coordination and Control of Blasting in TransCanada GTN System Easement and Control Zone. This project will take place adjacent to TransCanada GTN System's natural gas transmission line which is buried west of the Knott Landfill property boundary. If Contractor elects to conduct any blasting operations related to the project, the Contractor shall contact TransCanada GTN (541-548-9202) prior to the development of any blasting plans and accommodate all safety and blast control requirements as required by TransCanada GTN. All requirements mandated by TransCanada GTN shall be specified in the blasting plan and complied with for all work performed under this project.

D. Site Safety and Health Plan. The Contractor shall develop and maintain for the duration of this Contract, a site safety and health plan that will effectively incorporate and implement all required county, state, and federal safety provisions. Contractor shall provide a written site safety and health plan for the construction within ten (10) calendar days after receiving a Notice to Proceed and prior to commencing work on this project. Contractor shall maintain at least one copy of the plan at the work site. Contractor shall assign an individual serving as a Site Safety and Health Officer at the job site at all times during work who is responsible and authorized to supervise and enforce compliance with the site safety and health plan. In addition to the other items that shall be addressed, the site safety and health plan shall list the appropriate procedures to be followed in the event that hazardous wastes are encountered.

Preparation of the written site safety and health plan is the Contractor's responsibility, and no statement made in these provisions relieves the Contractor of responsibility for information included in, and implementation of, the site safety and health plan.

The Contractor's written site safety and health plan should include, but not be limited to:

- A list of chemical and physical hazards (including landfill hazards), allowable OSHA exposure levels, threshold limit values, other regulatory exposure levels, and the emergency response should an exposure or injury occur.
- An emergency evacuation plan for immediate removal to a hospital or a doctor's care any person who may be injured on the job site including evacuation plan routes to medical treatment, and emergency telephone numbers including hospital, ambulance, fire, sheriff/police, poison control, the Owner, and others as deemed necessary.
- A list of safety and monitoring equipment at the job site and locations where equipment is stored or expected to be maintained.
- Monitoring equipment action levels, frequency of testing, and recommended responses.
- Procedures for entering confined spaces.
- Procedures to be followed if hazardous waste is encountered.

The Contractor shall inform all workers and the public visiting the site of the potential for the presence of methane and other landfill gases emanating from the natural decomposition of waste buried at or near the job site and the importance of safety precautions to ensure the safety of workers and the public. The Contractor shall instruct all workers and maintain strict control of construction activity to protect and maintain the integrity of the landfill.

The Contractor shall, at the Owner's request, provide to the Owner a copy of the site safety and health plan. Failure on the part of the Contractor to follow the site safety and health plan or failure

to work in a safe manner may result in suspension of the work by the Owner. The Contractor shall not be entitled to extra compensation for health- and safety-related suspensions, nor shall the Contract completion date be extended.

E. Contractor Safety Equipment. As part of the safety program, the Contractor shall maintain at the job site safety equipment applicable to the work as prescribed by the governing safety authorities and all articles necessary for giving first aid to the injured.

The Contractor shall train all personnel in use of the appropriate safety equipment that would be utilized during the course of their work. It is the responsibility of the Site Safety and Health Officer to ascertain that all safety equipment is properly maintained and being used when appropriate.

F. Site Safety and Health Officer. The Contractor shall provide a person designated as the Site Safety and Health Officer who is thoroughly trained in rescue procedures and the use of safety equipment. The person must be present at all times while work is being performed, and implement the written site safety and health plan and conduct testing, as necessary.

The Contractor shall provide the Site Safety and Health Officer with the delegated authority to order any person or worker on the project site to follow the safety rules. Failure to observe these rules is sufficient cause for removal of the person or worker(s) from this project.

The Site Safety and Health Officer is responsible for determining the extent to which any safety equipment must be utilized, depending on conditions encountered at the site.

G. Payment. No separate or additional payment will be made for safety provisions, but shall be considered incidental to the work and shall be included in various unit or lump sum bid items.

Section 01100 - Temporary Water Pollution and Erosion Control

A. General. The Contractor is required to prevent, control, and stop water pollution or erosion within the project, thereby protecting the work, nearby land, streams, and other bodies of water.

Controlling pollution, erosion, runoff, and related damage may require the Contractor to perform temporary work items including but not limited to:

- Providing ditches, berms, culverts, and other measures to control surface water
- Building dams, settling basins, energy dissipaters, and other measures to control downstream flows
- Controlling underground water found during construction
- Covering or otherwise protecting slopes until permanent erosion-control measures are working.

To the degree possible, the Contractor shall coordinate this temporary work with any permanent drainage and erosion control work the Contract requires.

If the Owner orders the work suspended for an extended time, the Contractor shall make every effort to control erosion, pollution, and runoff during shutdown.

If natural elements rut or erode the slope, the Contractor shall restore and repair the damage, with the eroded material where possible, and clean up any remaining material in ditches and culverts. The Contractor shall bear all costs of repairing erosion damage.

The Owner may require temporary control measures if it appears pollution or erosion may result from weather, the nature of the materials, or progress on the work. The Owner may also require permanent erosion control work to be done with or immediately after grading.

When temporary control devices are no longer needed, the Contractor shall remove them and finish the areas they occupied as the Owner directs.

Nothing in this Section shall relieve the Contractor from complying with other Contract requirements.

The Contractor shall bear full responsibility for temporary water pollution/erosion control in all work areas and haul roads used by the Contractor.

B. Measurement and Payment. No separate or additional payment will be made for temporary water pollution and erosion controls, but shall be considered incidental to the work and shall be included in various unit or lump sum bid items.

Section 01150 - Measurement, Payment and Retained Amounts

A. Existing Topography and Earth Work Estimates. The Contractor shall satisfy himself as to the current existing site conditions.

B. Measurement and Payment - General. Measurement of pay items will be performed by the Owner and the Contractor according to the United States standard measures and based upon actual units of work performed or installed. The method of measurement is described under each bid item. Each lump sum bid item has a measurement section in them, stating that measurement will be by the lump sum.

Payment will be in accordance with the unit or lump sum prices shown on the Bid Schedule of the Contract Documents. The unit or lump sum contract prices shall constitute full compensation for each bid item including all costs for overhead, profit, fees, taxes, bonding, insurance, and for furnishing all plant, materials, labor, equipment, tools, and performing all operations required as well as all work incident or incidental to complete the work in accordance with the Contract Documents, and to provide operation and maintenance manuals, guarantees and warranties as well as as-built documentation of the completed work.

In the event that terms for "measurement and payment" and/or "measurement" and/or "payment" are not directly mentioned in a section, such omission shall be construed to mean that no separate or additional payment will be made for the work described in that section, but shall be considered incidental and included in various unit or lump sum bid items.

C. Retained Amount (Retainage). The amount to be retained from progress payments to protect the County's interests shall be five (5) percent of the value of work accomplished, and shall be withheld as described in Section 00195.50 of the ODOT Standard Specifications.

Section 01210 - Construction Scheduling

A. Construction Schedule. Within ten (10) calendar days after Notice to Proceed, or such later time as may be designated by the Owner, the Contractor shall prepare and submit to the Owner for review a construction schedule, showing the order in which the Contractor proposes to carry on the work, the dates on which salient features will be started (including the procurement of materials, plant and equipment) and the contemplated dates for completing the same.

The construction schedule shall be updated as determined by the Owner. The Owner will make no progress payments under this Contract until any requested construction schedule update has been submitted for review.

Review of any schedule submitted by the Contractor shall not be construed to assign responsibility of performance or contingencies to the Owner or relieve the Contractor of responsibility to adjust forces, equipment, and work schedules as may be necessary to ensure completion of the work within the prescribed contract time.

B. Revisions. If, in the opinion of the Owner, the Contractor's work activities are inconsistent with the order, sequence, or timing of the activities shown on the construction schedule, the Owner may require the Contractor to propose methods, such as providing additional equipment and/or workers, to complete the work within the specified time limit. The Owner may require the Contractor to submit supplementary construction schedules demonstrating the agreed rate of progress and the order and sequence of the work.

C. Failure to Comply. Failure of the Contractor to comply with the requirements of the Owner under the provisions of this section shall be grounds for determination by the Owner that the Contractor is not prosecuting the work with such diligence as will insure completion within the time specified. Upon such determination, the Owner may terminate the Contractor's right to proceed with the work, or any separable part thereof, in accordance with determination for default or in accordance with other provisions provided in the Contract Documents.

D. Payment. No separate or additional payment will be made for construction scheduling, but shall be considered incidental to the work and shall be included in various unit or lump sum bid items.

Section 01220 - Progress Meetings

A. General. The Owner and Contractor shall arrange for and conduct progress meetings as needed. These meetings shall be attended by the Owner and/or a designated representative, the Contractor's superintendent, and representatives of all subcontractors, utilities and others that are active in the execution of the work. The purpose of these meetings shall be to determine the status of the work; to resolve conflicts; and, in general, to coordinate and facilitate expeditious prosecution of the work.

The Owner and/or a designated representative will prepare the agenda of progress meetings which shall include review of the progress, payment requests, narrative reports, latest construction

schedule update, and record documents. The Owner and/or a designated representative will prepare and distribute meeting minutes.

B. Progress and Schedule Review. The progress of the work and the construction schedule shall be reviewed at the progress meetings to verify:

- Actual start and finish dates of completed activities since the last progress meeting
- Duration and progress of all activities not completed
- Reason, time and cost data for change order work that is to be incorporated into the construction schedule
- Payment due to the Contractor
- Reason and duration of required revisions.

C. Payment. No separate or additional payment will be made for progress meetings, but shall be considered incidental to the work and shall be included in various unit or lump sum bid items.

Section 01230 - Preconstruction Conference

A. General. After the Contract has been executed, but prior to the Contractor beginning the work, a preconstruction conference will be held between the Contractor, Owner, and such other interested or affected parties as may be invited. The purposes of the preconstruction conference will be:

- To review the initial construction schedule
- To establish a working understanding among the various parties associated or affected by the work
- To establish and review procedures for progress payment, notifications, approvals, submittals, etc.
- To establish normal working hours for the work
- To review safety standards and traffic control
- To discuss such other related items as may be pertinent to the work.

The Contractor shall prepare and submit at the preconstruction conference the following:

- A list of proposed subcontractors
- A construction schedule
- A haul routing and traffic control plan

B. Payment. No separate or additional payment will be made for Contractor attendance at the preconstruction conference, but shall be considered incidental to the work and shall be included in various unit or lump sum bid items.

Section 01510 - Maintenance of Existing Facilities during Construction and Contractor Coordination

A. General. The Contractor may remove, relocate or adjust such existing facilities that are to remain, as may be necessary for the performance of the work, and rebuild any such disturbed existing facilities in as good condition as found (with minimum requirements as herein specified).

The Contractor shall make all necessary or required revisions and perform all construction required by operations under the Contract, incident to any interference with power transmission and distribution, telephone, cable and other utility lines or with the maintenance of traffic or service thereon, all in a manner satisfactory to the owners and operators thereof.

The Contractor is warned that landfill environmental systems (groundwater monitoring, landfill gas management, leachate management, and landfill liner systems) exist at the Knott Landfill Recycling and Transfer Facility and Knott Landfill. Additional environmental system components may also be installed before and/or during the execution of this contract. These systems include but are not limited to such elements as wells, below ground and aboveground piping, and utility vaults, and are clearly marked in the field. These system components are not to be damaged or disturbed in any way by the construction activities or other operations of the Contractor. Should any of these environmental system components be damaged by the Contractor's operations, the Contractor will be required to replace damaged environmental system components at Contractor's expense.

B. Cooperation with Other Contractors. The Owner and others will be working at the Knott Landfill Recycling and Transfer Facility and Knott Landfill while the work is in progress. The Contractor shall schedule his work to minimize mutual interference, in accordance with Section 01045.

C. Coordination of Work. The Contractor shall maintain overall coordination for the execution of the work. Based on the progress schedule prepared in accordance with these Special Provisions, the Contractor shall obtain from each subcontractor a schedule and shall be responsible for all parties maintaining these schedules or for coordinating required modifications.

D. Payment. No separate or additional payment will be made for maintenance of existing facilities during construction and Contractor coordination, but shall be considered incidental to the work and shall be included in various unit or lump sum bid items.

Section 01530 - Temporary Facilities and Utilities

A. Electrical Service. The Contractor shall arrange with the local utility to provide adequate temporary electrical service, if required for Contractor's operations, at a mutually agreeable location. The Contractor shall then provide adequate job site distribution facilities conforming to applicable codes and safety regulations. The Contractor shall provide, at Contractor's expense, all electric power required for construction, testing, general and security lighting, and all other purposes whether supplied through temporary or permanent facilities.

B. Water. The Contractor shall pay for and shall construct any facilities necessary to furnish water for Contractor's use during construction. Water is available at two (2) hydrant locations adjacent to the project area. If Contractor elects to use these hydrants, the Contractor shall make the appropriate arrangements with Avion Water Company for use. Water used for human consumption shall be kept free from contamination and shall conform to the requirements of the State and local health requirements for potable water.

C. Temporary Lighting. The Contractor shall provide temporary lighting in all work areas sufficient to maintain a lighting level during working hours not less than the lighting level required by OSHA standards.

D. Sanitary Facilities. The Contractor shall provide suitable chemical toilets or water closets at appropriate locations within the site of the work. The facilities shall be serviced weekly or more often if necessary. At the end of the job such sanitary facilities shall be removed completely.

E. Payment. No separate or additional payment will be made for temporary facilities and utilities, but shall be considered incidental to the work and shall be included in various unit or lump sum bid items.

Section 01540 - Special Controls

A. Public Safety and Convenience. The Contractor shall at all times conduct work as to insure the least possible obstruction to traffic and inconvenience to the general public and the residents in the vicinity of the work, and to insure the protection of persons and property. No road or street shall be closed to the public except with the permission of the Owner and proper governmental authority.

The Contractor shall control dust by applying water by means of tank trucks equipped with spray bars. Spray controls shall ensure that the water flows evenly and in the amounts required by the Owner. The Owner may direct that the Contractor apply water at night or early in the morning to reduce evaporation losses. The Contractor shall keep all surfaced roads used for the Contractor's operations free of dust and accumulated debris caused by the Contractor's operations at all times. If necessary, the Contractor shall wash down roads as needed to remove accumulated dust and debris.

The Contractor shall conduct work, and take preventive measures, including performing dust control to minimize or reduce dust conditions, and such that dust in the project area shall not become objectionable to the adjacent property owners or in violation of any applicable federal, state or local laws, regulations or permits. Should the Owner determine the Contractor is not fulfilling obligations in this regard, the Owner reserves the right to take such action as may be necessary, and to charge the Contractor for any costs that may be incurred in such remedial action. No separate or extra measurement and payment of any kind will be made for dust control, including watering as may be necessary or required by the Owner.

All work shall be carried on with due regard for the safety of the public. Open trenches or cut faces shall be provided with barricades of a type that can be seen at a reasonable distance, and at night they shall be distinctly indicated by adequately placed lights. Safety instructions received from the Owner or applicable federal, state, or local agency shall be observed, but the following of such instructions shall in no way relieve the Contractor of responsibility or liability should any accident or loss occur as the result of Contractor's construction operations.

It shall be the Contractor's responsibility to see that all requirements of the Federal Williams-Steiger Occupational Safety and Health Act are observed and enforced to protect all the workers on the project, as well as the general public.

B. Noise. The Contractor shall comply with applicable federal, state and local rules and regulations. Daytime sound pressure levels shall comply with applicable federal, state and local regulations. All equipment working on the subject site shall be equipped with sound suppression devices.

All costs incurred by the Contractor to comply with the noise restrictions shall be considered incidental to the work and no separate or additional payment will be made.

B. Conditional Use Permit. The County has a Conditional Use Permit for blasting and crushing operations which has been included in Part VII of the Contract Documents. If the Contractor elects to utilize blasting as an excavation method, the Contractor shall be responsible for complying with all requirements and stipulations specified in the Conditional Use Permit and for procuring any additional permits necessary for blasting and crushing operations required by any local or state permitting authorities.

C. Payment. No separate or additional payment will be made for special controls, but shall be considered incidental to the work and shall be included in various unit or lump sum bid items.

Section 01570 - Traffic Maintenance and Protection

A. General. The Contractor shall provide traffic maintenance and protection in accordance with the ODOT Standard Specifications. The work shall be performed under a traffic control plan which has been reviewed by the Owner and shall create a minimum of interruptions or inconveniences to pedestrian and vehicular traffic. At the pre-construction conference, the Contractor shall provide a written plans for procedure of construction, traffic control, haul routing, safety provisions, sequence of operations and any other pertinent data relating to traffic regulation and protection for the public, as may be required.

B. Payment. No separate or additional payment will be made for traffic maintenance and protection, but shall be considered incidental to the work and shall be included in the various unit or lump sum bid items.

Section 01700 - Project Closeout

A. Cleanup. Throughout the period of construction the Contractor shall keep the work site free and clean of all rubbish and debris, and shall promptly remove from any portion of the site, or from property adjacent to the site of the work, all unused materials, surplus earth and debris, excepting select material which may be required for embankment, backfill, or grading.

Upon completion of the work, and prior to final acceptance, the Contractor shall remove from the vicinity of the work all plant, surplus material and equipment belonging to or used under Contractor's direction during construction.

B. Waste Disposal. The Contractor shall dispose of surplus materials, waste products and debris within the project site at locations to be directed by the Owner. Ditches, washes, or drainage ways shall not be filled if this action may create water control problems. Disposal operations shall not

create unsightly or unsanitary nuisances. The Contractor shall maintain the project site in a condition of good appearance and safety during the construction period.

C. Touch-Up and Repair. The Contractor shall touch-up or repair finished surfaces on structures, equipment, fixtures or installations that have been damaged prior to final acceptance. Surfaces on which such touch-up or repair cannot be successfully accomplished shall be completely refinished or, in the case of hardware and similar small items, the item shall be replaced.

D. Releases. The Contractor shall furnish, before final acceptance, a written release from the property owners of each property disturbed or otherwise interfered with by reason of construction pursued under this Contract, including disposal sites, whenever any of the work is accomplished on or through property other than that owned by the Owner. Should the release be, in the opinion of the Owner, arbitrarily withheld, the Owner may, at its sole discretion, accept that portion of the work involved and cause final payment therefore to be made. The release must be signed by the property owner, or proper authority acting for the property owner, of the property affected, stating that the restoration of the property has been satisfactorily accomplished.

E. Payment. No separate or additional payment will be made for project closeout, but shall be considered incidental to the work and shall be included in the various unit or lump sum bid items.

Section 01710 - Contract Closeout Procedure

A. Final Inspection. Final inspection at project closeout shall be in general accordance with the following steps:

1. The Contractor shall request final inspection when all work is substantially completed
2. The Owner will make a final inspection within a reasonable time after Contractor's request for final inspection.
3. Should the Owner consider that work is complete in accordance with requirements of Contract Documents, the Owner will notify the Contractor in writing.
4. Should the Owner consider that work is not complete in accordance with requirements of Contract Documents:
 - a. Owner shall notify the Contractor in writing stating reasons.
 - b. The Contractor shall take immediate steps to remedy the stated deficiencies and request a follow-up final inspection.
 - c. The Owner will reinspect work.

B. Closeout Submittals. At the time of project closeout, Contractor shall: submit any Guarantees, Bonds and Letters of Credit required by these specifications.

C. Utilities and Temporary Services. At the close of the Contract the Contractor shall:

- a. Pay all utility bills.

- b. Remove all electrical, telephone, water, offices and any other temporary service equipment that may remain.

D. Release of Liens or Claims. Final acceptance will not be given until satisfactory evidence of release of liens has been submitted to the Owner. Prior to release of retainage, Contractor shall provide the Owner with a consent of surety to release retainage.

E. Final Acceptance. Following satisfactory completion of the final punch list items and all the items listed above, the Owner will provide the Contractor with Final Acceptance which will begin any applicable warranty periods. Date of Final Acceptance from the Owner sets the completion date of the Contract.

F. Final Application for Payment. Upon final acceptance by the Owner, the Contractor shall submit a final application for payment. Upon receipt of the final application for payment, the Owner will issue final payment.

Should final completion be materially delayed through no fault of the Contractor, the Owner may issue a final payment, in accordance with the specifications and existing laws.

G. Post-Construction Inspection. The Owner will promptly notify the Contractor, in writing, of any observed deficiencies.

H. Measurement and Payment. No separate or additional payment will be made for contract closeout procedure, but shall be considered incidental to the work and shall be included in the various unit or lump sum bid items.

Division 2: Site Work

Section 02010 - Site Conditions

A. General. Portions of the compost relocation area have been subject to fill placement in depths ranging from 1 to 5 feet in thickness. The existing fill material placed consists primarily of 24-inch minus fill material.

It is estimated that 4,687 cubic yards of excavation (cut) and 8,336 cubic yards of embankment (fill) are necessary to construct the subgrade fill to the lines and grades shown on the plans. An existing stockpile consisting of 2,865 cubic yards of mixed aggregate material is stockpiled in the project area for use as embankment material for the project.

The above description presented in good faith and is not intended as a substitute for personal investigation, independent interpretation, or the judgment of the Bidder. The Bidder shall make his own deductions and conclusions as to the volume and nature of the materials to be excavated and placed as embankment and operations surface, and difficulties that may arise from subsurface conditions and of doing any other work affected by surface and subsurface conditions, and shall accept full responsibility thereof.

B. Payment. No extra or additional payment will be made over and above the contract price due to any difference between the information relating to surface and subsurface conditions provided by the Owner and the conditions disclosed at the site of the work during the progress of the contract.

Section 02100 – Mobilization

A. Description. This work shall consist of preconstruction costs of preparatory work and operations performed by the Contractor, including, but not limited to, those necessary for the movement of his personnel, equipment, supplies and incidentals to the project site; for the establishment of his offices, buildings and other facilities necessary for work on this project; for the preparation of the health and safety plan; for premiums on bonds and insurance for the project and for work and operations which he must perform or costs he must incur before beginning production work on the various items on the project site. This cost also includes demobilization upon completion of the project. Mobilization costs for all subcontracted work shall be considered to be included in the costs for Mobilization.

B. Measurement and Payment. Measurement and payment for Mobilization shall be in accordance with Section 01150 and the following:

1. Measurement: Shall be measured by lump sum, and shall not exceed ten (10%) percent of the overall contract cost.
2. Payment: Shall be paid for at the applicable contract lump sum price, payment for which shall constitute full compensation for project mobilization, including move in of personnel and equipment; set up of all temporary offices, facilities and utilities; provision of parking facilities for personnel working on the project; preparation of site health and safety plan; preparation of the Contractor staging area; preconstruction expenses; costs of the preparatory work and operations; and demobilization performed by the Contractor in association with this Contract as described in the Contract Documents.

The lump sum amount bid for mobilization may be invoiced for payment when on site construction operations commence.

Section 02200 - Excavation and Embankment

General. This work consists of the excavation of cut areas and the placement of suitable excavated material in the subgrade fill areas, the hauling and stockpiling of unsuitable and excess excavated materials, and the hauling and placement of any Owner approved borrow material necessary for subgrade fill construction. This work also includes the excavation of the drainage swale and stormwater retention pond. This shall include all other associated work and incidentals necessary to complete the work as shown on the drawings and as described in the specifications, in conformity with the details shown in the drawings, and as directed by the Owner.

It is estimated that 4687 cubic yards of excavation (cut) and 8336 cubic yards of embankment (fill) are necessary to construct the subgrade fill to the lines and grades shown on the plans. An existing stockpile consisting of 2,865 cubic yards of mixed aggregate material is stockpiled in the project area for use as embankment material for the project.

A. Materials. Material excavated from cut areas and the stormwater pond and the mixed aggregate stockpile in the project area shall be utilized for the construction of required subgrade

embankment in the project area. Excavated material unsuitable for use as subgrade embankment fill shall be hauled and placed in the Excess Material Stockpile Area shown on the drawings.

Subject to Owner approval, additional fill material required for subgrade embankment construction can be made available in the Subgrade Borrow Stockpile, as shown on the drawings.

B. Execution. The Contractor shall inform and satisfy himself in regard to the character, quantity and distribution of all materials to be excavated.

The Contractor shall perform all excavation of every description, regardless of the type, nature or condition of material encountered within the limits of the project to the lines and grades indicated on the drawings. The Contractor will encounter basalt rock boulder fill of varying size and undisturbed basalt rock in varying degrees of weathering and hardness. The basalt rock may be rippable; however, if harder and/or massive zones of basalt rock are encountered, pneumatic hammering or blasting may be required.

Haul truck traffic in the project area shall be continuously and uniformly routed over the entire width of the excavation and embankment areas. If continued hauling over a completed or partially complete embankment causes the loss of stability as evidenced by pumping, rutting or other damage, The Contractor shall repair the damaged embankment at his own expense and adjust his hauling equipment routes and procedures to avoid further damage.

Embankment fill material placement and compaction shall be performed in a manner that achieves volumetric stability of the embankment. The Contractor shall submit a subgrade embankment placement plan to the Owner for review and approval. The subgrade embankment placement plan shall specify the processes for subgrade embankment material placement, compaction, water conditioning and grading and any other procedures to be employed for completing the embankment surface to the lines and grades as shown on the drawings.

C. Measurement and Payment Measurement and payment for Excavation and Embankment shall be in accordance with Section 01150 and the following:

1. Measurement: Shall be measured and paid for by lump sum complete and in place.
2. Payment: Shall be paid for at the applicable contract lump price, payment for which shall constitute full compensation for preparing the project area (including clearing and grubbing), excavating, loading, hauling, spreading, placing and compacting of subgrade embankment material; excavation and grading of drainage swale and stormwater retention pond; and for all other associated work and incidentals necessary to complete the work as shown on the drawings and as described in the specifications, in conformity with the details shown in the drawings, and as directed by the Owner.

Section 02222 – Excavation, Backfilling and Compaction for Utilities

A. General. This work consists of the excavation, backfilling and compaction work required for the installation of the water lines and electrical conduits and all other associated work and incidentals necessary to complete the work as shown on the drawings and as described in the specifications, in conformity with the details shown in the drawings, and as directed by the Owner.

B. Materials.

1. Gravel Bedding Material and Backfill material for Water Lines and Conduits: Bedding and backfill material shall consist of clean, granular, well graded screened or crushed sand and gravel material conforming to the following gradation when tested in accordance with ASTM D441:

| Sieve Size Square Opening | Percent Passing By Weight |
|------------------------------|------------------------------|
| 3/4 inch | 100 |
| 3/8 inch | 95-100 |
| No. 8 | 0-10 |
| No. 200 | 0-3 |

Minimum sand equivalency shall be 35 in accordance with ASTM D2419.

2. Submittals: The Contractor shall provide the Owner with a certificate of gradation or sieve analysis from a qualified testing laboratory for bedding material and backfill gravel furnished for this project.

C. Execution. The Contractor shall perform Excavation, Backfilling and Compaction for Utilities in accordance with the following:

1. Trenching
 - a. Unless suitable for use as backfill or embankment, materials excavated from trenches shall be hauled and placed in the Excess Material Stockpile Area shown on the drawings.
 - b. Ledge rock, boulders or stones shall be removed to provide a minimum clearance of 6 inches under and around pipe and conduit.
2. Trenching for Water Lines
 - a. Trenches shall be dug to true and smooth bottom grades and in accordance with the drawings.
 - b. As much as is practical, trench widths shall not exceed 30 inches in width.

- c. Depth of trenching for water lines shall be as such to give a minimum cover of 30 inches over the top of the pipe, unless otherwise specified.
 - d. Trenches shall be over excavated below the specified depth to provide for the specified bedding material placement.
- 3. Trenching for Electrical Service Conduits
 - a. Trenching shall be in accordance with the requirements of CEC and Section 02661.
- 4. Pipe and Conduit Foundations
 - a. Where the trench bottom is in a material that is unsuitable for foundation or which will make it difficult to obtain uniform bearing for the pipe or conduit, such material shall be removed and a stable foundation provided.
 - b. Proper preparation of foundation and placement of foundation material where required, shall precede the installation of pipe or conduit. This shall include the necessary preparation of the native trench bottom and/or top of the foundation material to a uniform grade so that the entire length if the pipe or conduit rests firmly on a suitable properly compacted material.
 - c. Gravel to be used for foundation purposes shall be of a type and gradation to provide a solid compact bedding in the trench.
 - d. Neither approval nor disapproval of the foundation material proposed by the Contractor shall relieve him of his responsibility for providing adequate pipe or conduit foundation and guaranteeing his work as elsewhere required by the Contract.
 - e. Unsuitable material for foundation purposes below the depth required for the specified bedding shall be removed and replaced with suitable foundation gravel.
- 5. Pipe Bedding
 - a. Placement of bedding material in the pipe zone shall be as specified in section 02660.
- 6. Backfilling
 - a. Pipe and conduit bedding and backfill to six (6) inches over the top of the pipe or conduit shall be completed before backfilling operations are started.
 - b. The Contractor shall take all necessary precautions to protect pipe and conduit from damage, movement or shifting. In general, backfilling shall be performed by pushing the material from the end of the trench into, along and directly over the pipe or conduit so that the material will be applied in the form of a rolling slope rather than by side filling which may damage the pipe or conduit. Backfilling from the sides of the trench will be permitted after sufficient material has first been carefully placed over the pipe or conduit to such a depth as to protect the pipe or conduit.
 - c. Compaction equipment used above the pipe or conduit zone shall be of a type that does not injure the pipe or conduit.
 - d. Make adequate provisions for safety of property and persons.
 - e. Temporary cribbing, sheeting, or other timbering shall be removed unless specifically authorized in writing.
 - f. Provide utility excavation warning tape with backfill.

7. General Compaction Requirements
 - a. Requirements of this section shall apply unless more stringent requirements are established by the local agency involved.
 - b. Trench backfill shall be mechanically compacted to 95% of maximum density.

8. Mechanical Compaction
 - a. Method of compaction shall be at Contractor's option.
 - b. The Contractor shall be responsible to provide the proper size and type of compaction equipment and shall select the proper method of utilizing said equipment to attain the required compaction density.
 - c. In place compaction tests may be performed. Contractor shall remove and recompact material that does not meet specific requirements.

D. Measurement and Payment. No separate or additional payment will be made for Excavation, Backfilling and Compaction for Utilities, but shall be considered incidental to the work and shall be included in the various unit or lump sum bid items.

Section 02250 – Drilling and Blasting

A. General. The use of drilling and blasting as a method of excavation is at the Contractor's option. This work shall consist of the drilling, blasting, processing, hauling of in-place basalt and all other associated work and incidentals necessary to complete the work as shown on the drawings and as described in the specifications, in conformity with the details shown in the drawings, and as directed by the Owner.

The County has a Conditional Use Permit for aggregate production and storage at Knott Landfill, which places conditions on blasting and crushing operations. The Conditional Use Permit has been included in Part VII-Appendix of the Contract Documents. The Contractor shall be responsible for complying with all requirements and stipulations specified in the Conditional Use Permit, with the exception of notifications to surrounding property owners, and for procuring any additional permits necessary for blasting and crushing operations required by any local or state permitting authorities.

The Contractor shall provide five (5) days minimum notice to the Owner for all scheduled blasting activities to facilitate Owner notifications to surrounding property owners, as required by the Conditional Use Permit.

B. Site Preparation. The Contractor shall perform all site preparation work necessary for drilling and blasting. Any soil which must be removed from the rock removal area prior to drilling and blasting operations shall be stockpiled adjacent to the landfill working face as directed by the Owner.

C. Drilling and Blasting. Blasting operations shall be performed in accordance with Section 00335 of the ODOT Standard Specifications except as otherwise provided herein and with the following modifications:

1. Amend Subsection 00335.40 (d) for notifications to property owners and occupants to be performed by the Owner.
2. Amend Subsection 00335.40 (e) for submittal of Blasting Plan to TransCanada GTN for review and approval
3. Delete Subsection 00335.40 (f)
4. Amend Subsection 00335.40 (g) for review and approval of blasting plan by TransCanada GTN.
5. Delete subsection 00335.80
6. Delete subsection 00335.90

Immediately after blasting operations, the Contractor shall remove all shot rock that may have migrated out of the project area.

D. Coordination with TransCanada. Blasting operations shall be performed in accordance with TransCanada requirements as follows:

1. The minimum distance from the pipeline to be determined for allowable blasting.
2. There shall be NO blasting within TransCanada's pipeline right-of-way.
3. The Contractor shall conduct blasting such that ground stability is not compromised on TransCanada's pipeline right-of-way.
4. Under all circumstances for blasting within 300 meters of a TransCanada facility, the Contractor shall monitor all blasting for vibration levels and peak particle velocity over the pipeline.
 - a. The maximum amplitude of vibration shall be 0.1524 mm (0.006")
 - b. The maximum horizontal particle velocity shall be 50 mm/s (1.969 in/s)
 - c. The charge size shall be set so that the ground movement does not exceed the vibration level and peak particle velocity over the pipeline as specified above.
5. At no time can construction equipment cross the pipeline without prior consent from TransCanada, except at the approved crossings.
6. Beyond 60 meters and within 300 meters of the pipeline, the charge size shall be set so that the ground movement does not exceed those specified in section 4 above.
7. The Contractor shall remove any blasting debris from TransCanada's right-of-way.

8. The Contractor shall provide documentation of instrumentation calibration to TransCanada's representative prior to blasting. The Contractor shall provide all instrumentation measurements to TransCanada's representative after blasting.
9. For blasting at distances less than 60 meters from the pipeline, the charge per delay sizes will be determined. A stake out report shall be completed by the Contractor and submitted to TransCanada with the blasting plan. TransCanada will run an analysis to determine the allowable charge sizes per delay and will relay those numbers in writing to the Contractor.

E. Measurement and Payment. No separate or additional payment will be made for drilling and blasting, but shall be considered incidental to the work and shall be included in the various unit or lump sum bid items.

Section 02610 – Irrigation System: Pipe and Fittings

A. General. Furnish and install 3-inch and 4-inch polyvinyl chloride (PVC) water service lines, five (5) single-head and two (2) double-head frost-free valve stations, one (1) 4-inch overhead standpipe and remove and reinstall one 4-inch water meter, double check valve assembly (DCVA), and all other associated work and incidentals necessary to complete the work as shown on the drawings and as described in the specifications, in conformity with the details shown in the drawings, and as directed by the Owner.

Avion Water Company uses the City of Bend Standards and Specifications for Water Facilities as the standards for their water system and these standards shall be applicable for irrigation system pipe and fittings.

B. Materials.

1. Meter and DCVA:
 - a. Furnished by the Owner. An existing 4-inch water meter and DCVA that is currently in use at the facility shall be used for the Avion water service connection for the project. Installation shall be in accordance with Avion Water Company requirements and as shown on the Drawings.
2. Water Meter and DCVA Utility Vaults:
 - a. In accordance with Avion Water Company requirements and as shown on the Drawings. See Drawings W-5B and W-13B.
3. Overhead Standpipe Station
 - a. As shown on the Drawings.
4. Frost-Free Valve Stations (Single and Double-Head):
 - a. As shown on the Drawings.
5. 3-inch PVC Pipe:
 - a. Conform to ASTM D2241
 - b. Pipe material shall be PVC 1120, PVC 1220 or PVC 2120.

- c. Minimum wall thickness shall be equal to or greater than a standard dimension ratio (SDR) of 21 unless otherwise specified.
 - d. Pipe shall bear the National Sanitation Foundation Seal for use to transport potable water.
 - e. Joints shall conform to ASTM D3139 using a restrained rubber gasket conforming to ASTM F477.
6. 4-inch PVC Pipe
- a. Conform to AWWA C900
 - b. Outside diameter equal to ductile iron pipe and with gasket bell ends
 - c. Minimum wall thickness shall be equal to or greater than a dimension ratio (DR) of 18 (150 psi) unless otherwise specified.
 - d. Joints shall conform to ASTM D3139 using a restrained rubber gasket conforming to ASTM F477.

C. Measurement and Payment. No separate or additional payment will be made for irrigation system pipe and fittings, but shall be considered incidental to the work and shall be included in the various unit or lump sum bid items.

Section 02660 – Irrigation System: Installation

A. General. Furnish and install 3-inch and 4-inch polyvinyl chloride (PVC) water service lines, (5) single-head and two (2) double-head frost-free valve stations, one (1) overhead standpipe and remove and reinstall one 4-inch water meter, double check valve assembly (DCVA), and all other associated work and incidentals necessary to complete the work as shown on the drawings and as described in the specifications, in conformity with the details shown in the drawings, and as directed by the Owner.

Avion Water Company uses The City of Bend Standards and Specifications for Water Facilities as the standards for their water system and these standards shall be applicable for water line installation.

A. Materials.

1. Bedding and Backfill Materials: Conform to Section 02222.

B. Execution

1. Bedding
 - a. Shall be carefully placed under the pipe and to a depth of at least six (6) inches over the top of the pipe.
 - b. Shall be thoroughly rammed and tamped around the pipe with the proper tools so as to provide a uniform support over the full length of all pipe, valves and fittings.
 - c. Care shall be taken to prevent any damage to the pipe or any protective coatings.
2. Pipe Laying
 - a. Pipe laying shall be performed in accordance with the specifications and instructions of the pipe manufacturer.

- b. Short Lengths of pipe and field cuts:
 - i. Short lengths of pipe supplied by the manufacturer shall be used to provide the proper spacing of valves, tees or special fittings.
 - ii. Whenever it is necessary to cut a length of pipe, the cut shall be made by abrasive saw or by a special pipe cutter.
 - iii. Pipe ends shall be square with the longitudinal axis of the pipe and shall be reamed and otherwise smoothed so good connections can be made.
 - iv. Threads shall be cleanly cut.
 - v. All operations for any connections shall be carefully executed in conformance with the manufacturer's instructions.

- 3. Laying of Pipe on Curves
 - a. Long radius curves, either horizontal or vertical, may be laid with standard pipe by deflection at the joints or by the use of shorter lengths of pipe.
 - b. When pipe is laid on a curve, the pipe shall be jointed in a straight alignment and then deflected to the curved alignment.
 - c. Where field conditions require deflection or curves not anticipated by the Plans, the Contractor shall use deflected joints, short length or special fittings as required. No additional payment will be made for laying pipe on curves as shown on the Plans or for field changes involving pipe deflected at the joints.
 - d. Maximum deflections at pipe joints shall be as recommended by the pipe manufacturer.

- 4. Contamination Prevention
 - a. Pipe, fittings and valves shall be carefully cleaned of all dirt and foreign material as they are placed.
 - b. Open ends of pipe and fittings shall be plugged with a temporary watertight plug whenever work is stopped and/or when water in the trench threatens to enter the pipe.
 - c. Groundwater shall be excluded from the pipe at all times.

- 5. Condition of Pipe and Fittings
 - a. The interior of all pipe, fittings and other accessories stockpiled on the project site shall be kept free of dirt and other foreign matter at all times.
 - b. Each pipe, fitting or other accessory shall be carefully inspected and thoroughly cleaned of any dirt or foreign material that might be present.
 - c. Cleaning shall be accomplished prior to lowering the pipe or other accessory into the trench.
 - d. Care shall be taken to keep materials internally clean after the pipe is placed in the trench.

- 6. Blocking and Bracing
 - a. For restrained joint pipe and fittings, use a mechanical joint with a MEGALUG follower gland as manufactured by the EBAA Iron Corporation, PO Box 857, Eastland, Texas, or equal. Other acceptable restrained joints are the "Loc-Tyte" joint as manufactured by the Pacific States Cast Iron Pipe Company and the United States Pipe and Foundry Company, the "Locked Fastite" joint as manufactured by the

American Cast Foundry Company, the “TR Flex” joint as manufactured by the United States Pipe and Foundry Company, the “Snap-Lok” joint as manufactured by the Griffin Pipe Products Company. Set screw type retainer glands and joint harness systems will not be allowed. The maximum allowable deflection for all joints shall not exceed 80% of the maximum deflections recommended by the manufacturer.

- b. Restrained Joints: Install restrained joints at all required locations and as shown on the Plans, in accordance with the manufacturer’s instructions for the type of restrained joint used.
 - c. Thrust Blocking: Install thrust blocking at all tees and bends in accordance with Avion Water Company requirements, industry standards and practices and as shown on the Drawings.
7. Frost-Free Valve Stations:
- a. Install five (5) single head frost-free valve stations and two (2) double-head frost-free valve station in accordance with the Drawings.
8. 4-inch Overhead Standpipe
- a. Install in accordance with the drawings
9. Removal of Existing Water Meter and DCVA
- a. Care shall be taken during excavation to expose subgrade water meter and DCVA to ensure that the devices are not damaged.
 - b. After removal, abandon existing water service connection in accordance with the Drawings and the requirements of Avion Water Company.
10. Connection to Existing Water Main
- a. Install water meter and DCVA in accordance with the Drawings and the requirements of Avion Water Company.
 - b. Connections to the existing main shall not be made without first notifying the Owner.
 - c. Work shall not be started until all of the materials, equipment and labor necessary to properly complete the work are assembled on site.
 - d. When work is started on this connection, it shall proceed continuously without interruption and as rapidly as possible until completed.
 - e. The Contractor shall not operate any valves on the existing system without specific permission of the owner.
 - f. Interior of pipe and fittings used in making connections shall be swabbed or sprayed with 1% solution of hypochlorite before they are installed.
11. Placing in Operation
- a. Upon completion of the work and before its final acceptance, the entire system shall be put in operation under normal pressure and operated at that pressure for a period of not less than ten (10) days by the Contractor.
 - b. Any leaks or defects in the construction of the system that may develop shall be repaired and the test continued until the system is practically watertight.

- c. Prior to final inspection, all pipelines shall be flushed and cleaned of debris, disinfected and hydrostatically tested in accordance with industry and Avion Water Company standards and requirements.
- d. No provision of the section shall be construed as waiving any provision of the Contractor's guarantee.

D. Measurement and Payment Measurement and Payment for Irrigation System: Water Line Installation shall be in accordance with Section 01150 and the following:

1. 4-inch Water Meter and DCVA:
 - a. Measurement: Shall be measured and paid for by lump sum complete and in place.
 - b. Payment: Shall be paid for at the applicable unit price, payment for which shall be full compensation for the removal and reinstallation of the 4-inch water meter and DCVA, complete and in place including existing meter and DCVA excavation and removal; and excavation, assembly, installation, bedding and backfilling and furnishing all necessary pipe, fittings and all incidental work and materials necessary for a complete installation as shown on the drawings and as described in the specifications, in conformity with the details shown in the drawings, and as directed by the Owner.
2. 4-inch Overhead Standpipe:
 - a. Measurement: Shall be measured and paid for by lump sum complete and in place.
 - b. Payment: Shall be paid for at the applicable unit price, payment for which shall be full compensation for the installation of the 4-inch overhead standpipe, complete and in place including excavation, assembly, installation, and furnishing all necessary pipe, fittings, valves, thrust blocking and removal and reinstallation of existing overhead standpipe above ground components and all incidental work and materials necessary for a complete installation as shown on the drawings and as described in the specifications, in conformity with the details shown in the drawings, and as directed by the Owner.
3. Single-Head Frost Free Valve Station
 - a. Measurement: Shall be measured and paid on a per each basis complete and in place.
 - b. Payment: Shall be paid for at the applicable unit price, payment for which shall be full compensation for the installation of double-head frost-free valve stations, complete and in place including excavation, assembly, installation, thrust blocking, bedding and backfilling and furnishing all necessary pipe, fittings and valves and all incidental work and materials necessary for a complete installation as shown on the drawings and as described in the specifications, in conformity with the details shown in the drawings, and as directed by the Owner.
4. Double-Head Frost Free Valve Station
 - a. Measurement: Shall be measured and paid on a per each basis complete and in place.

- b. Payment: Shall be paid for at the applicable unit price, payment for which shall be full compensation for the installation of single-head frost-free valve stations, complete and in place including excavation, assembly, installation, thrust blocking, bedding and backfilling and furnishing all necessary pipe, fittings and valves and all incidental work and materials necessary for a complete installation as shown on the drawings and as described in the specifications, in conformity with the details shown in the drawings, and as directed by the Owner.
- 5. 3-Inch Water Line:
 - a. Measurement: Shall be measured and paid on a per lineal foot basis complete and in place.
 - b. Payment: Shall be paid for at the applicable unit price, payment for which shall be full compensation for the installation of 3-inch water line, complete and in place including excavation, assembly, installation, bedding and backfilling and furnishing all necessary pipe, fittings, thrust blocking and all incidental work and materials necessary for a complete installation as shown on the drawings and as described in the specifications, in conformity with the details shown in the drawings, and as directed by the Owner.
- 6. 4-Inch Water Line
 - a. Measurement: Shall be measured and paid on a per lineal foot basis complete and in place.
 - b. Payment: Shall be paid for at the applicable unit price, payment for which shall be full compensation for the installation of 4-inch water line, complete and in place including excavation, assembly, installation, bedding and backfilling and furnishing all necessary pipe, fittings, thrust blocking and all incidental work and materials necessary for a complete installation as shown on the drawings and as described in the specifications, in conformity with the details shown in the drawings, and as directed by the Owner.

Section 02661 – Electrical System

A. General. Furnish and install electrical service and electrical distribution systems.

Electrical service system includes furnishing and installing two (2) 4-inch PVC electrical service conduits from existing transformer utility vault to utility vault installed by Contractor at compost relocation area, furnishing and installing utility vault and lid and meter base. and all other associated work and incidentals necessary to complete the work as shown on the drawings and as described in the specifications, in conformity with the details shown in the drawings, and as directed by the Owner. Central Electric Cooperative (CEC) specifications and standards for materials and work shall be applicable to the installation of 4-inch electrical service conduit, utility vault and meter base.

Electrical distribution system includes furnishing and installing 2-inch electric distribution conduits, blower control panel stub-outs and posts, blower power panel stub-outs and posts and

all other associated work and incidentals necessary to complete the work as shown on the drawings and as described in the specifications, in conformity with the details shown in the drawings, and as directed by the Owner. The requirements and standards of the National Electric Code (NEC), latest adopted version, and any additional requirements of the local permitting authority shall be applicable to the installation of 2-inch electrical distribution conduits.

B. Materials.

1. Electrical Service Conduit: Two (2) 4-inch Schedule 40 UL approved PVC conduits in accordance with the in accordance with requirements of CEC (Drawing UG-110). Ells: in accordance with CEC requirements and standards.
2. Utility Vault and Lid:
 - a. Utility Vault Model #687-2-CEC Base
 - b. Utility Vault Lid Model #687-8" Top with 243P door and 17" x 52" blackout
3. Meter Base: Sized for 480 volt, 200 Amp service and in accordance with CEC standards and requirements.
4. Electrical Distribution Conduit: Two (2) inch Schedule 40 UL approved PVC conduit. Ells: Schedule 40 PVC, UL approved, 24" radius.

C. Execution.

1. Electrical Service Conduit:
 - a. Install in accordance with Drawings and in accordance with CEC requirements.
 - b. Make conduit connection to existing utility vault in accordance with CEC requirements.
 - c. Install pull rope in accordance with CEC requirements (Drawing UG-110)
 - d. Provide utility excavation warning tape in backfill.
 - e. Restore asphalt concrete road in kind at electrical service conduit crossing.
2. Utility Vault:
 - a. Install in accordance with manufacturer and CEC requirements.
3. Meter Base: Install in accordance with standards and requirements of CEC, NEC and local permitting authority.
4. Electrical Distribution Conduit:
 - a. Place a minimum of 3-inch cover of bedding material that conforms with Section 02222 around the conduit on a leveled and uniform trench bottom. Lay conduit on a smooth level trench bottom, so that contact is made for its entire length. Remove water from trench before electrical conduit is installed.
 - b. Maximum bend: Install code sized pull boxes to limit the sum of bends in a run of conduit to 270 degrees.
 - c. Provide continuous polypropylene pull cord in all conduits (no knots).
 - d. Provide utility excavation warning tape in backfill.

D. Measurement and Payment Measurement and payment for Electrical System shall be in accordance with Section 01150 and the following:

1. Electrical Service System:

- a. Measurement: Shall be measured and paid for by lump sum complete and in place.
 - b. Payment: Shall be paid for at the applicable unit price, payment for which shall be full compensation for the installation of the electrical service system, complete and in place including excavation, assembly, installation, bedding and backfilling and furnishing all necessary conduit and fittings, utility vault and lid, meter base, and all incidental work and materials necessary for a complete installation as shown on the drawings and as described in the specifications, in conformity with the details shown in the drawings, and as directed by the Owner.
2. Electrical Distribution System:
- a. Measurement: Shall be measured and paid for by lump sum complete and in place.
 - b. Shall be paid for at the applicable unit price, payment for which shall be full compensation for the installation of the electrical distribution system, complete and in place including excavation, assembly, installation, bedding and backfilling and furnishing all necessary conduit and fittings, blower control panel stub-out and posts, blower power panel stub-outs and posts and all incidental work and materials necessary for a complete installation as shown on the drawings and as described in the specifications, in conformity with the details shown in the drawings, and as directed by the Owner.

PART V
BID PROPOSAL FORMS

Bid Proposal
Bid Schedule
Bid Bond
First-Tier Subcontractor Disclosure Form

BID PROPOSAL

To: Deschutes County Department of Solid Waste
61050 SE 27th Street
Bend, Oregon 97702

Project Name: Knott Landfill Compost
Facility Relocation Project

The undersigned, hereinafter called the Bidder, declares that the only persons or parties interested in this Proposal are those named herein; that this Proposal is, in all respects, fair and without fraud; and it is made without collusion with any official of Deschutes County, Oregon, hereinafter called County; and that the Proposal is made without any connection or collusion with any person making another proposal on this Contract.

The Bidder further declares that he has carefully examined the Contract documents; that he has satisfied himself as to the quantities involved, including materials and equipment, and conditions of work involved; and that this proposal is made according to the provisions and under the terms of the Contract documents, which documents are hereby made a part of this Proposal.

The Bidder agrees that all of the applicable provisions of Oregon law relating to public contracts (ORS Chapter 279) are, by this reference, incorporated in and made a part of this Proposal. Bidder hereby states that bidder will comply with ORS 279C.840.

Bidder (is) (is not) a resident bidder of the State of Oregon. If Bidder is a resident of another state, specify state of residency:

_____.

The Bidder further agrees that if this Proposal is accepted, he will, within ten (10) calendar days after notification of acceptance, execute the contract with the County in the form of contract annexed hereto; and will, at the time of execution of the contract, deliver to the County the Performance and Payment Bonds (See Section 13 - Information for Bidders) required herein; and will, to the extent of this Proposal, furnish all materials necessary to complete the work in the manner, in the time, and according to the methods as specified in the contract documents and required by the Director of Solid Waste.

Bidder certifies that it has a drug testing program in place for its employees, or warrants that a drug testing program will be in place prior to execution of this contract, that the drug testing program is in writing, that new employees must pass a drug screening, that existing employees may be tested for reasonable cause or when an employee is injured or involved in an accident resulting in property damage. Bidder agrees that each subcontractor providing labor under this Contract shall maintain a qualifying drug testing program for the duration of the Contract.

The Bidder agrees to commence work upon the issuance of a "Notice to Proceed" by the County and fully complete the project according to the time schedule specially set forth in the contract documents. Bidder further agrees to pay liquidated damages for failure to complete within the specified time.

It is agreed that if the Bidder is awarded the contract for the work herein proposed and shall fail or refuse to execute the contract and furnish the contract and furnish the specified Performance and Payment Bond within ten (10) calendar days after receipt of notification of acceptance of his proposal, then, in that event, the bid security deposited herewith according to the conditions of the Invitation to Bid and Information for Bidders shall be retained by the County as liquidated damages; and it is agreed that the said sum is a fair measure of the amount of damage the County will sustain in case the Bidder shall fail or refuse to enter into the contract for the said work and to furnish the Performance and Payment Bond (See Section 13 Information for Bidders) as specified in the contract documents. Bid security in the form of a certified check shall be subject to the same requirements as a bond.

If the Bidder is awarded a contract on this Proposal, the Surety who will provide the performance bond will be

_____, whose address is

STREET

CITY

STATE

ZIP

BID SCHEDULE

KNOTT LANDFILL COMPOST FACILITY RELOCATION PROJECT

| <u>ITEM #</u> | <u>ITEM DESCRIPTION</u> | <u>QUANTITY</u> | | <u>UNIT PRICE</u> | <u>COST</u> |
|---------------|--|-----------------|--------|-------------------|-------------|
| 1 | MOBILIZATION | 1 | LS | \$ _____ | \$ _____ |
| 2 | COMPOST PAD EXCAVATION AND EMBANKMENT PLACEMENT AND GRADING | 1 | LS | \$ _____ | \$ _____ |
| 3 | 4-INCH WATER METER AND DOUBLE CHECK VALVE ASSEMBLY | 1 | LS | \$ _____ | \$ _____ |
| 4 | 4-INCH OVERHEAD STANDPIPE | 1 | LS | \$ _____ | \$ _____ |
| 5 | SINGLE-HEAD FROST FREE VALVE STATION | 5 | EACH | \$ _____ | \$ _____ |
| 6 | DOUBLE-HEAD FROST FREE VALVE STATION | 2 | EACH | \$ _____ | \$ _____ |
| 7 | 3-INCH WATER LINE | 735 | LIN FT | \$ _____ | \$ _____ |
| 8 | 4-INCH WATER LINE | 445 | LIN FT | \$ _____ | \$ _____ |
| 9 | ELECTRICAL SERVICE SYSTEM | 1 | LS | \$ _____ | \$ _____ |
| 10 | ELECTRICAL DISTRIBUTION SYSTEM | 1 | LS | \$ _____ | \$ _____ |

TOTAL BID PRICE: \$ _____

TOTAL: BID PRICE (written words):

- NOTES:
- A. Bidder must bid on all items #1 through #10.
 - B. All bids must be accompanied by a bid security in the amount of ten percent (10%) of the Total Bid Price.
 - C. The successful Bidder must post both a Performance and Payment Bond each in the amount of one hundred percent (100%) of the awarded contract amount Total Bid Price to guarantee that the successful bidder will fulfill all of his obligations under this Contract.

ACKNOWLEDGEMENT OF ADDENDUMS

The undersigned acknowledges receipt of and has incorporated the addenda listed below in the Total Bid Price submitted herein:

| Addenda # | Signature | Date |
|-----------|-----------|-------|
| _____ | _____ | _____ |
| _____ | _____ | _____ |
| _____ | _____ | _____ |
| _____ | _____ | _____ |

It is understood that the right is reserved by Deschutes County to reject any or all proposals or bids. In the event that the Contract is not awarded within thirty (30) days after the receipt of bids, the Bidder will be released from his bid unless an extension of time is mutually agreed upon.

The undersigned certifies the bid prices contained in this proposal or bid have been carefully checked and are submitted as correct and final.

The name of the Bidder submitting this Proposal is:

_____ of
NAME CCB# TELEPHONE

_____ of
ADDRESS CITY STATE ZIP

Which is the address to which all communication concerning this proposal and the Contract shall be sent.

The names of the principal officers of the corporation submitting this Proposal, or of the partnership, or of all persons interested in this Proposal as principals, are as follows:

(IF SOLE PROPRIETOR OR PARTNERSHIP)

IN WITNESS HERETO, the undersigned has set his/her hand this _____ day of _____, 2016.

Signature of Bidder

Title

(IF CORPORATION)

IN WITNESS WHEREOF, the undersigned corporation has caused this instrument to be executed and its seal affixed by its duly authorized officers this _____ day of _____, 2016.

Name of Corporation

By: _____

Title: _____

Attest: _____
Signature and Title

Bid Bond

Bond No. _____

KNOW ALL MEN BY THESE PRESENTS, that _____
_____, hereinafter called the Principal, and _____,
a corporation duly organized under the laws of the State of _____, having its principal place of business at
_____ in the state of _____, and authorized to do business in the State of
Oregon, as Surety, are held and firmly bound unto the _____
hereinafter called the Oblige, in the penal sum of _____ DOLLARS
(\$ _____), for the payment of which, well and truly to be made, we bind ourselves, our heirs, executors,
administrators, successors and assigns, jointly and severally, firmly by these presents.

The condition of this Bond is that, whereas the Principal herein is herewith submitting his or its bid proposal for the KNOTT
LANDFILL COMPOST FACILITY RELOCATION PROJECT, said bid proposal, by reference thereto, being made a part
hereof.

NOW THEREFORE, if the said bid proposal submitted by the said principal be accepted, and the Contract be awarded to said
Principal, and if the said Principal shall execute the proposed Contract and shall furnish the Performance and Payment Bond as
required by the bidding and Contract documents with the time fixed by said documents, then this obligation shall be void,
otherwise to remain in full force and effect. Signed and sealed this ____ day of _____, 2016.

SURETY

CONTRACTOR

Name

Name

By: _____

By: _____

Title: _____

Title: _____

FIRST-TIER SUBCONTRACTOR DISCLOSURE FORM

KNOTT LANDFILL COMPOST FACILITY RELOCATION PROJECT

BID CLOSING TIME AND DATE: **2:00 pm, Thursday, March 17, 2016**

NAME OF BIDDING CONTRACTOR: _____

This form must be submitted at the location specified in the Invitation to Bid on the advertised bid closing date and within two working hours (4:00 p.m.) after the advertised bid closing time.

List below the name of each subcontractor that will be furnishing labor or materials and that is required to be disclosed, the category of work that the subcontractor will be performing and the dollar value of the subcontract. Enter "NONE" if there are no subcontractors that need to be disclosed. (ATTACH ADDITIONAL SHEETS IF NEEDED.)

| NAME | DOLLAR VALUE | CATEGORY OF WORK |
|----------|--------------|------------------|
| 1) _____ | \$ _____ | _____ |
| 2) _____ | \$ _____ | _____ |
| 3) _____ | \$ _____ | _____ |
| 4) _____ | \$ _____ | _____ |
| 5) _____ | \$ _____ | _____ |
| 6) _____ | \$ _____ | _____ |
| 7) _____ | \$ _____ | _____ |

Failure to submit this form by the disclosure deadline will result in a non-responsive bid. A non-responsive bid will not be considered for award.

Form Submitted by (Bidder Name): _____

Contact Name: _____ Phone No.: _____

PART VI
AGREEMENT FORMS

Contract
Performance Bond
Payment Bond
Certificate of Insurance

CONTRACT

THIS CONTRACT, made and entered into, in duplicate, by and between DESCHUTES COUNTY, a political subdivision of the State of Oregon, hereinafter called "County" and _____
_____, hereinafter called "Contractor", for the project entitled:

Knott Landfill Compost Facility Relocation Project

WITNESSETH:

THAT the said Contractor, in consideration of the sums to be paid by the County in the manner and at the times herein provided, and in consideration of the other covenants and agreements herein contained, hereby agrees to perform and complete the work herein described and provided for, and to furnish all necessary things in accordance with the applicable contract documents, bound herewith, and in accordance with such alterations or modifications of the same as may be made by the County, and according to and within the meaning and purpose of this contract. This Agreement shall be binding upon the heirs, executors, administrators, successors and assigns of the Contractor.

THAT the Contract Documents, consisting of Invitation to Bid, Information for Bidders, General Conditions, Special Provisions, Bid Proposal, Bid Schedule, Award, Bid Bond, Subcontractor Disclosure, Contract, Performance Bond, Payment Bond, Certificate of Insurance, Prevailing Wage Rates, Oregon Standard Specifications, Plans and Drawings bound herewith are hereby specifically referred to and by this reference made a part hereof, and shall by such reference have the same force and effect as though all of the same were fully written or inserted herein.

THAT the Contractor shall faithfully complete and perform all of the obligations of this Contract, and in particular, shall promptly, as due, make payment of all just debts, dues, demands and obligations incurred in the performance of said Contract; and shall not permit any lien or claim to be filed or prosecuted against the County, its agents or employees. It is expressly understood that this Contract in all things shall be governed by the laws of the State of Oregon, and the Ordinances of the County.

THAT in consideration of the faithful performance of all of the obligations, general and special, herein set out, and in consideration of the faithful performance of the work as set forth in the Contract Documents in accordance with the directions of the Director of Solid Waste and to his satisfaction, the County agrees to pay to the said Contractor the amount earned, as determined from the quantities of work performed, and taking into consideration any amounts that may be deductible and under the terms of the Contract, and to make such payments in the manner and at the times provided in the applicable provisions, and schedule of contract prices.

IN WITNESS WHEREOF, DESCHUTES COUNTY has caused this agreement to be signed in its name, by its Board of County Commissioners, duly attested by its Recording Secretary; and the said Contractor has caused this Contract to be signed and sealed the same as of the _____ day of _____, 2016.

BOARD OF COUNTY COMMISSIONERS
OF DESCHUTES COUNTY, OREGON

ALAN UNGER, CHAIR

TAMMY BANEY, VICE CHAIR

ANTHONY DeBONE, COMMISSIONER

ATTEST:

RECORDING SECRETARY

CONTRACTOR:

BY: _____

TITLE: _____

APPROVED:

TIMM SCHIMKE, DIRECTOR OF SOLID WASTE

APPROVED AS TO FORM:

LEGAL COUNSEL

Performance Bond

Bond No. _____

KNOW ALL MEN BY THESE PRESENTS: that

(Name of Contractor)

(Address of Contractor)

a _____, hereinafter called
(Corporation, Partnership, or Individual)

Principal, and _____
(Name of Surety)

hereinafter called Surety, are held and firmly bound unto Deschutes County, hereinafter called OWNER, in the penal sum of _____ dollars (\$ _____) in lawful money of the United States, for the payment of which sum well and truly to be made, we bind ourselves, successors, and assigns, jointly and severally, firmly by these presents.

THE CONDITION OF THIS OBLIGATION is such that whereas, the Principal entered into a certain Contract with the Owner, dated the _____ day of _____, 2016, a copy of which is hereto attached and made a part hereof for the construction of the **Knott Landfill Compost Facility Relocation Project**.

NOW THEREFORE, if the Principal shall well, truly and faithfully perform its duties, all the undertakings, covenants, terms, and conditions, and agreements of said contract during the original term thereof, and any extensions thereof which may be granted by the OWNER, with or without notice to the Surety and during the **TWO YEAR GUARANTY PERIOD**, and if he shall satisfy all claims and demands incurred under such contract, and shall fully indemnify and save harmless the OWNER from all costs and damages which it may suffer by reason of failure to do so, and shall reimburse and repay the OWNER all outlay and expense which the OWNER may incur in making good any default, then this obligation shall be void; otherwise to remain in full force and effect.

PROVIDED FURTHER, that the said surety, for value received hereby stipulates and agrees that no change, extension of time, alteration or addition to the terms of the Contract or to WORK to be performed thereunder or the SPECIFICATIONS accompanying the same shall in any wise affect its obligation on this BOND, and it does hereby waive notice of any such change, extension of time, alteration or addition to the terms of the Contract or to the WORK or the SPECIFICATIONS.

PROVIDED FURTHER, that no final settlement between the OWNER and the PRINCIPAL shall abridge the right of any beneficiary hereunder, whose claim may be unsatisfied.

IN WITNESS WHEREOF, this instrument is executed in _____ counterparts, each one of which shall be deemed an original,
this _____ day of _____ 2016.

ATTEST:

(Principal) Secretary

(Seal)

Principal

BY: _____

Witness as to Principal

Address

Address

Surety

ATTEST:

(Surety) Secretary

(Seal)

Agent of Record

Telephone Number

Witness as to Surety

Address

BY: _____
Attorney-in-Fact

Address

NOTE: Date of BOND must not be prior to date of Contract.
If CONTRACTOR is partnership, all partners should execute BOND.

Payment Bond

Bond No. _____

KNOW ALL MEN BY THESE PRESENTS: that

(Name of Contractor)

(Address of Contractor)

a _____, hereinafter called
(Corporation, Partnership, or Individual)

Principal, and _____
(Name of Surety)

hereinafter called Surety, are held and firmly bound unto Deschutes County, hereinafter called OWNER, in the penal sum of
_____ dollars (\$_____)

in lawful money of the United States, for the payment of which sum well and truly to be made, we bind ourselves, successors, and assigns, jointly and severally, firmly by these presents.

THE CONDITION OF THIS OBLIGATION is such that whereas, the Principal entered into a certain Contract with the Owner, dated the ____ day of _____, 2016, a copy of which is hereto attached and made a part hereof for the construction of the **Knott Landfill Compost Facility Relocation Project**.

NOW, THEREFORE, if the Principal shall promptly make payment as due to all persons, firms, SUBCONTRACTORS, and corporations furnishing materials for or performing labor in the prosecution of the WORK provided for in said contract, and any authorized modification thereof, including all amounts due for materials, lubricants, oil, gasoline, coal and coke, repairs on machinery, equipment and tools consumed or used in connection with the construction of such WORK, and all insurance premiums on said WORK, and for all labor performed in such WORK whether by SUBCONTRACTOR or otherwise, then this obligation shall be void; otherwise to remain in full force and effect.

PROVIDED FURTHER, that the said surety for value received hereby stipulates and agrees that no change, extension of time, alteration or addition to the terms of the Contract or to the WORK to be performed thereunder or the SPECIFICATIONS accompanying the same shall in any wise affect its obligation on this BOND, and it does hereby waive notice of any such change, extension of time, alteration or addition to the terms of the Contract or to the WORK or to the SPECIFICATIONS.

PROVIDED FURTHER, that no final settlement between the OWNER and the CONTRACTOR shall abridge the right of any beneficiary hereunder, whose claim may be unsatisfied.

IN WITNESS WHEREOF, this instrument is executed in _____ counterparts, each one of which shall be deemed an original, this _____ day of _____ 2016.

ATTEST:

(Principal) Secretary

(Seal)

Principal

BY: _____

Witness as to Principal

Address

Address

Surety

ATTEST:

(Surety) Secretary

(Seal)

Agent of Record Telephone Number

Witness as to Surety

Address

BY: _____
Attorney-in-Fact

Address

NOTE: Date of BOND must not be prior to date of Contract.
If CONTRACTOR is partnership, all partners should execute BOND.

DESCHUTES COUNTY SERVICES CONTRACT

Contract No. 2016-___

INSURANCE REQUIREMENTS

Contractor shall at all times maintain in force at Contractor's expense, each insurance noted below. Insurance coverage must apply on a primary or non-contributory basis. All insurance policies, except Professional Liability, shall be written on an occurrence basis and be in effect for the term of this contract. Policies written on a "claims made" basis must be approved and authorized by Deschutes County.

Project: Knott Landfill Compost Relocation Project

Contractor Name: TBD

Workers Compensation insurance in compliance with ORS 656.017, requiring Contractor and all subcontractors to provide workers' compensation coverage for all subject workers, or provide certification of exempt status. Worker's Compensation Insurance to cover claims made under Worker's Compensation, disability benefit or any other employee benefit laws, including statutory limits in any state of operation with Coverage B Employer's Liability coverage all at the statutory limits. . In the absence of statutory limits the limits of said Employers liability coverage shall be not less than \$1,000,000 each accident, disease and each employee. This insurance must be endorsed with a waiver of subrogation endorsement, waiving the insured's right of subrogation against County.

Professional Liability insurance with an occurrence combined single limit of not less than:

| | |
|--------------------------------------|--------------------------------------|
| Per Occurrence limit | Annual Aggregate limit |
| <input type="checkbox"/> \$1,000,000 | <input type="checkbox"/> \$2,000,000 |
| <input type="checkbox"/> \$2,000,000 | <input type="checkbox"/> \$3,000,000 |
| <input type="checkbox"/> \$3,000,000 | <input type="checkbox"/> \$5,000,000 |

Professional Liability insurance covers damages caused by error, omission, or negligent acts related to professional services provided under this Contract. The policy must provide extended reporting period coverage, sometimes referred to as "tail coverage" for claims made within two years after the contract work is completed.

Required by County Not required by County (one box must be checked)

Commercial General Liability insurance with a combined single limit of not less than:

| | |
|---|---|
| <u>Per Single Claimant and Incident</u> | <u>All Claimants Arising from Single Incident</u> |
| <input checked="" type="checkbox"/> \$1,000,000 | <input checked="" type="checkbox"/> \$2,000,000 |
| <input type="checkbox"/> \$2,000,000 | <input type="checkbox"/> \$3,000,000 |
| <input type="checkbox"/> \$3,000,000 | <input type="checkbox"/> \$5,000,000 |

Commercial General Liability insurance includes coverage for personal injury, bodily injury, advertising injury, property damage, premises, operations, products, completed operations and contractual liability. The insurance coverages provided for herein must be endorsed as primary and non-contributory to any insurance of County, its officers, employees or agents. Each such policy obtained by Contractor shall provide that the insurer shall defend any suit against the named insured and the additional insureds, their officers, agents, or employees, even if such suit is frivolous or fraudulent. Such insurance shall provide County with the right, but not the obligation, to engage its own attorney for the purpose of defending any legal action against County, its officers, agents, or employees, and that Contractor shall indemnify County for costs and expenses, including reasonable attorneys' fees, incurred or arising out of the defense of such action.

The policy shall be endorsed to name ***Deschutes County, its officers, agents, employees and volunteers as an additional insured.*** The additional insured endorsement shall not include declarations that reduce any per occurrence or aggregate insurance limit. The contractor shall provide additional coverage based on any outstanding

claim(s) made against policy limits to ensure that minimum insurance limits required by the County are maintained. Construction contracts may include aggregate limits that apply on a "per location" or "per project" basis. The additional insurance protection shall extend equal protection to County as to Contractor or subcontractors and shall not be limited to vicarious liability only or any similar limitation. To the extent any aspect of this Paragraph shall be deemed unenforceable, then the additional insurance protection to County shall be narrowed to the maximum amount of protection allowed by law.

Required by County Not required by County (One box must be checked)

Automobile Liability insurance with a combined single limit of not less than:

Per Occurrence

- \$500,000
 \$1,000,000
 \$2,000,000

Automobile Liability insurance includes coverage for bodily injury and property damage resulting from operation of a motor vehicle. Commercial Automobile Liability Insurance shall provide coverage for *any* motor vehicle (symbol 1 on some insurance certificates) driven by or on behalf of Contractor during the course of providing services under this contract. Commercial Automobile Liability is required for contractors that own business vehicles registered to the business. Examples include: plumbers, electricians or construction contractors. An Example of an acceptable personal automobile policy is a contractor who is a sole proprietor that does not own vehicles registered to the business.

Required by County Not required by County (one box must be checked)

Additional Requirements. Contractor shall pay all deductibles and self-insured retentions. A cross-liability clause or separation of insured's condition must be included in all commercial general liability policies required by this Contract. Contractor's coverage will be primary in the event of loss.

Certificate of Insurance Required. Contractor shall furnish a current Certificate of Insurance to the County with the signed Contract. Contractor shall notify the County in writing at least 30 days in advance of any cancellation, termination, material change, or reduction of limits of the insurance coverage. The Certificate shall also state the deductible or, if applicable, the self-insured retention level. Contractor shall be responsible for any deductible or self-insured retention. If requested, complete copies of insurance policies shall be provided to the County.

Risk Management review



Date

January 14, 2016

PART VI

**CONDITIONAL USE PERMIT FOR
AGGREGATE PRODUCTION AND
STORAGE AT KNOTT LANDFILL**



Community Development Department

Planning Division Building Safety Division Environmental Health Division

117 NW Lafayette Avenue Bend Oregon 97701-1925
(541)388-6575 FAX (541)385-1764
<http://www.co.deschutes.or.us/cdd/>

NOTICE OF CORRECTED DECISION

On September 29, 2008, the Planning Division mailed a Findings and Decision for the proposal detailed below. In that decision, staff inadvertently added language to a Finding and a Condition of Approval regarding drilling and blasting that does not correspond to the referenced approval criterion. Specifically, criterion 18.52.110(J)(2)(c) provides limits on the hours and days of operation for blasting. Staff incorrectly included drilling under this limitation. Below, staff has corrected this error via ~~strikeout~~underline

The Deschutes County Planning Division has approved the land use application(s) described below:

FILE NUMBER: CU-08-61/SP-08-25

LOCATION: The property is located at 60800 27th Street, Bend, and is identified on County Assessor's Map 18-12-14, as Tax Lot 500.

APPLICANT: Deschutes County Department of Solid Waste

SUBJECT: The Deschutes County Planning Division has approved an application to allow processing (crushing) and stockpiling of material excavated at the Knott Landfill.

STAFF CONTACT: Anthony Raguine, Senior Planner, (541) 617-4739

APPLICABLE CRITERIA: The Planning Division reviewed this application for compliance against criteria contained in Sections 18.52.040, 18.52.050, 18.52.090, 18.52.110 and 18.52.140 of Title 18, the DCC Zoning Ordinance and the procedural requirements of Title 22 of the DCC.

DECISION: Staff finds that the application satisfies all applicable criteria, and approval is being granted subject to the following conditions:

1. This approval is based upon the site plan and information submitted by the applicant. Any substantial change in the approved plan will require a new application.
2. The applicant shall follow and meet all requirements of the site-specific ESEE analysis.
3. Any dust and noise created from the mining operation and associated activities at this site shall be controlled so as to meet applicable DEQ standards, and in such a manner as not to be a nuisance as defined in OAR 340-21-050. Watering or chemical treatment

Quality Services Performed with Pride

of the roads on the site used for access shall be required where deemed necessary to prevent a nuisance. The access roads shall be maintained for safety.

4. All mining operations shall be conducted between the hours of 7:00 a.m. and 5:00 p.m., Monday through Friday. No surface mining operations shall be conducted on Saturdays, Sundays or the following legal holidays: New Year's Day, Memorial Day, July 4th, Labor Day, Thanksgiving Day, Christmas Day.
5. ~~Drilling and blasting~~ Blasting to excavate the materials shall only be allowed between the hours of 9:00 a.m. to 5:00 p.m., Monday through Friday. The applicant shall send the required notice under section 18.52.110(J)(2)(d) for the drilling and blasting.
6. Any exterior lighting used for the surface mining operation shall meet all requirements of Chapter 15.10, Outdoor Lighting, of the Deschutes County Code.
7. The applicant (or contractor) shall obtain an Air Contaminant Discharge Permit from the Oregon Department of Environmental Quality, and submit a copy to the Planning Division, prior to commencement of any crushing on the site. The rock crusher shall be located below natural ground level to reduce the amount of noise generated from the site, as specified on the submitted plan.
8. The existing topographic and vegetative screening for the surface mine shall be maintained and/or replaced to assure screening throughout the duration of the crushing operation.
9. Only equipment, structures and materials related to proposed surface mining shall be allowed on the surface mining site. All surface mining equipment and related structures shall be removed from the site within 30 days of completion of all mining and reclamation.
10. No onsite sales of excavated or crushed material shall be allowed for the site.

This land use permit shall be void two (2) years from the date this decision becomes final unless the permit is initiated or extended pursuant to Chapter 22.36 of the DCC.

This decision becomes final twelve (12) days after the date mailed, unless appealed by a party of interest. To appeal, it is necessary to submit a Notice of Appeal, the appeal fee of \$250.00 and a statement raising any issue relied upon for appeal with sufficient specificity to afford the Hearings Body an adequate opportunity to respond to and resolve each issue.

Copies of the application, all documents and evidence submitted by or on behalf of the applicant and applicable criteria are available for inspection at no cost. Copies can be purchased for 25 cents per page.

Pending land use applications can be accessed online at www.deschutes.org/cdd. Click on "Property Development" heading, then click on "Pending Land Use Applications" located on right side of page (opens in new window)

NOTICE TO MORTGAGEE, LIENHOLDER, VENDOR OR SELLER: ORS CHAPTER 215 REQUIRES THAT IF YOU RECEIVE THIS NOTICE, IT MUST BE PROMPTLY FORWARDED TO THE PURCHASER.

Dated this 2nd day of October 2008

Mailed this 2nd day of October 2008



Community Development Department

Planning Division Building Safety Division Environmental Health Division

117 NW Lafayette Avenue Bend Oregon 97701-1925
(541)388-6575 FAX (541)385-1764
<http://www.co.deschutes.or.us/cdd/>

CORRECTED FINDINGS & DECISION

On September 29, 2008, the Planning Division mailed a Findings and Decision for the proposal detailed below. In that decision, staff inadvertently added language to a Finding and a Condition of Approval regarding drilling and blasting that does not correspond to the referenced approval criterion. Specifically, criterion 18.52.110(J)(2)(c) provides limits on the hours and days of operation for blasting. Staff incorrectly included drilling under this limitation. Below, staff has corrected this error via ~~strikeout~~/underline.

FILE NUMBERS: CU-08-61/SP-08-25

APPLICANT/OWNER Timm Schimke, Director
Deschutes County Department of Solid Waste
61050 SE 27th Street
Bend, OR 97702

PROPOSAL: The applicant is requesting a conditional use permit and site plan review to allow crushing and storage of excavated material at the Knott Landfill.

STAFF CONTACT: Anthony Raguine, Senior Planner

I. APPLICABLE CRITERIA:

Title 18 of the County Code, the County Zoning Ordinance:
Chapter 18.52, Surface Mining Zone – SM
Sections 18.52.020, .040, .050, .090, .110, .115, .130, .140, .170

II. BASIC FINDINGS:

- A. **LOCATION:** The subject property is located at 60800 27th Street, Bend, and is identified on County Assessor map 18-12-14, as tax lot 500.
- B. **ZONING:** The property is zoned Surface Mining (SM).
- C. **SITE DESCRIPTION:** The subject property is approximately 135 acres in size and is the site of the County's landfill and recycling center. The topography of the site ranges from level to moderately sloping, as well as deep pits for refuse disposal. The undisturbed portions of the site have a vegetative cover of scattered juniper and ponderosa pine

Quality Services Performed with Pride

trees and an understory of scrub brush and grasses. Access to the landfill site and recycling center is from a driveway off of SE 27th Street. There are several buildings on the site, including an office, storage buildings, maintenance building, weigh station building, and refuse receiving building.

The Knott landfill site has been in operation under a valid DEQ permit for approximately 36 years, since 1972.

- D. PROPOSAL:** The applicant is requesting approval of a conditional use permit and site plan review to process (crush) and store material excavated at the landfill. Based on the submitted application and a conversation with Department of Solid Waste staff, the processing and storage operation would cover an approximately 36-acre rectangle oriented lengthwise east to west within the landfill, and would be completed in two phases. The first phase would begin shortly after receiving approval, and would be located in the westerly 12 acres of the rectangle. Phase two would begin in approximately one year, and would be located in the easterly 24 acres of the rectangle. The applicant proposes the following hours of operation: Monday through Friday, 7:00 a.m. to 5:00 p.m.

Based on staff's site visit with Department of Solid Waste personnel, the crusher would be located approximately 25 feet below the level of SE 27th Street. The crusher would be located in an existing excavated area which has been leveled for this use. The proposed operation also involves the storage of crushed materials in the eastern portion of the processing rectangle. Excavated and crushed material would be loaded onto trucks for transport to the storage areas. The applicant submitted the following information in support of this application:

1. Burden of proof statement
2. Closure/Reclamation plan (Attachment A)
3. Site Plan (Attachment B)
4. DEQ General Permit for Rock Crushers (Attachment C)
5. Noise Level Comparison (Attachment D)

These materials are incorporated by reference herein.

- E. SURROUNDING LAND USE:** The surrounding area has public uses including: High Desert Middle School (approximately 825 feet to the northwest), Central Electric Cooperative Office (approximately 1,300 feet to the north), and the Humane Society facility (approximately 2,600 feet to the north). To the north of the subject site is a large vacant publicly owned block of land (18-12, tax lots 1700 and 1800, State of Oregon, 634 acres), and directly west is a vacant parcel owned by the Bend Metro Park and Recreation District (18-12-14, tax lot 200, 31.71 acres). Directly south, across Rickard Road, is a surface mining operation commonly known as the Rose Pit (Surface Mine Site No. 392, 18-12-23, tax lot 300).

To the west are High Desert Veterinary Services (18-12-15, tax lot 1901) and Bend Pet Resort (18-12-15, tax lot 200), each with an associated dwelling. The dwelling on tax lot 1901 is located approximately 1,800 feet to the southwest of the processing and storage area. The dwelling on tax lot 200 is located approximately 1,700 feet to the west. The closest dwellings to the proposed processing and storage area appear to be at least

1,200 feet to the east (18-12-14, tax lot 600) and 1,500 feet south (County Assessor map 18-12-14, tax lot 400).

The properties surrounding the subject property are zoned Exclusive Farm Use (EFU) to the north, east and south, and Urban Area Reserve (UAR) to the west. The zoning also includes the Surface Mining Impact Area (SMIA) combining zone associated with surface mining site nos. 390 and 392.

F. LOT OF RECORD: The subject property is a legal lot of record via several previously issued land use approvals, and building and septic permits.

F. PUBLIC AGENCY COMMENTS: The Planning Division sent notice of the proposal to several public agencies and received the following responses:

Deschutes County Building Division: Building permits and proper plan review would be required per 2007 OSSC Code for any structures used in this operation.

Bend Fire Department:

1. **Obstruction & Protection of Fire Hydrant – 2007 Oregon IFC 508.5.4 through 508.5.6**
A 3-foot clear space shall be maintained around the circumference of fire hydrants. When exposed to vehicular damage, concrete curbing, sidewalks, or 4 inch concrete filled bollards placed 3 feet from hydrants shall suitably protect fire hydrants. Hydrants shall be coated with approved red paint color and markings.
2. **Premises Identification - 2007 Oregon IFC 505.1**
Approved numbers or addresses shall be placed on all new and existing buildings in such a position as to be plainly visible and legible from the street or road fronting the property. Said numbers shall contrast with their background and visible at night. Dwellings and Foster Homes that are located off of street frontage shall post a visible approved reflective address sign at the entrance to their driveway. (Signs are available at local Fire Stations)
3. **Street or Road Signs - 2007 Oregon IFC 505.2**
Streets and roads shall be identified with approved signs. Signs shall be of an approved size and weather resistive construction.
4. **Fire Lanes - 2007 Oregon IFC 503.3**
Approved signs or other approved notices shall be provided for fire apparatus access roads to identify such roads or prohibit the obstruction thereof. Such signs or notices shall be kept in legible condition at all times. Fire lane curbs shall be painted bright red with white letters. The stroke shall be 1 inch with letters 6 inches high to read "No Parking Fire Lane". Spacing for signage shall be every 50 feet.
5. **Portable Fire Extinguishers - 2007 Oregon IFC Section 906**
Fire extinguisher ratings and travel distances shall not be less than that specified in Tables 906.3(1) and 906.3(2) of Section 906. Portable fire extinguishers shall be selected, installed and maintained in accordance with Section 906 and NFPA

10. Additional portable fire extinguishers may be required by the applicable code sections found in Table 906.1.

6. **Key Boxes - 2007 Oregon IFC Section 506**

Key Box (Knox Box) for Fire Department access is required to be installed at all locked access gates and barriers. An application for the Knox Box is available by calling the Fire Prevention office at (541) 322-6309.

7. **Gas Meters & Piping - 2007 Oregon IFC Section 312**

Aboveground gas meters, regulators and piping exposed to vehicular damage due to proximity to alleys, driveways or parking areas shall be protected in an approved manner.

The following agencies did not respond, or responded with no comment: County Assessor, County Environmental Health Division, and County Road Department.

G. **PUBLIC NOTICE AND COMMENTS:** The Planning Division sent written notice of this administrative action to property owners within 250 feet of the subject property. A response was received from Bob and Karen Marcotte on August 13, 2008 (included herein by reference). The letter identifies the following issues:

1. Crushing, sorting, and blasting outside of the approved operational hours
2. Dust control should be required
3. Odor from the landfill
4. Bird feces

I. **REVIEW PERIOD:** This application was submitted on July 30, 2008, and deemed complete on August 29, 2008. The 150th day upon which the County must take action on this application is January 26, 2009.

J. **POSTED NOTICE:** The applicant submitted a land use action sign affidavit dated August 7, 2008 indicating that the sign was posted on the same day.

III. **CONCLUSIONARY FINDINGS:**

A. **Chapter 18.52, Surface Mining Zone – SM**

1. Section 18.52.020, Application of ordinance.

Except as provided in DCC 18.52.160, the setbacks, operation standards and conditions set forth in DCC 18.52.090, 18.52.110 and 18.52.140, respectively, apply to every surface mining site and activity to the extent that setbacks, standards and conditions are not expressly provided for in the site-specific ESEE analysis within the surface mining element of the Comprehensive Plan. When there is a conflict between the site-specific ESEE analysis and the provisions of DCC 18, the site-specific ESEE analysis shall control.

FINDING: The proposed conditional use and site plan review applications are subject to sections 18.52.050, 18.52.070, 18.52.080, 18.52.090, 18.52.110 and 18.52.140, which

the applicant has addressed in the burden of proof statement. The ESEE analysis is addressed in findings below.

2. Section 18.52.040. Uses permitted outright subject to site plan review.

The following uses are permitted outright subject to site plan review as provided in this section:

- A. **Extraction of minerals.**
- B. **Stockpiling and storage of minerals.**
- C. **Screening, washing and sizing of minerals.**
- D. **Sale of minerals and mineral products extracted and produced on the parcel or contiguous parcels in the same ownership.**
- E. **Buildings, structures, apparatus, equipment and appurtenances necessary for the above uses to be carried on.**

FINDING: The applicant is proposing a surface mining operation that consists of processing (crushing) and storage of extracted material on-site. Applicable approval criteria related to processing and storage are addressed below.

The material would be excavated from areas to be used for future landfill operations, and then crushed and stored on-site, and used to backfill the landfill area. No sales of the mineral products produced on the site would occur. The applicant has not indicated that any buildings or structures are proposed as part of the operation. Apparatus and equipment would be used to extract and process the minerals, including a rock crusher.

3. Section 18.52.050. Conditional uses permitted.

B. **The following uses are permitted subject to site plan review and the setbacks, standards and conditions set forth in DCC 18.52.090, 18.52.110 and 18.52.140, respectively, and are not subject to the conditions in DCC 18.128:**

- ...
- 2. **Crushing of mineral and aggregate materials on sites designated for crushing in the ESEE analysis in the surface mining element of the Comprehensive Plan.**

FINDING: The applicant is proposing to crush aggregate minerals on the site. The ESEE analysis for site no. 390, item 23, Program to Meet the Goal, states, "The Board finds that processing on site will be allowed." Processing includes the crushing of minerals as listed under section 18.04.030, Definition – Surface mining, processing. Consequently, the crushing of minerals on the site can be allowed if the conditional use criteria are met. The proposal's conformance with the conditional use criteria is addressed below.

4. Section 18.52.090. Minimum use setbacks.

A. **Except as otherwise provided in this section, all surface mining activities and uses, including structures, shall be located and conducted at least 250 feet from a noise-sensitive or dust-sensitive use or structure. Exceptions to this standard shall be allowed....**

- B. Storage and processing of mineral and aggregate material, and storage of operational equipment which creates noise and dust, shall not be allowed closer than one-quarter mile from any noise or dust sensitive use or structure existing on the effective date of Ordinance No. 90-014, unless the applicant demonstrates that....**

FINDING: Deschutes County Code, Section 18.04, provides the following definitions of dust-sensitive and noise-sensitive uses:

Dust-sensitive use means real property normally used as a residence, school, church, hospital or similar use. Property used in industrial or agricultural activities is not "dust-sensitive" unless it meets the above criteria in more than an incidental manner. Accessory uses such as garages and workshops do not constitute dust-sensitive uses.

Noise-sensitive use means real property normally used for sleeping or normally used as schools, churches, hospitals or public libraries. Property used in industrial or agricultural activities is not "noise-sensitive" unless it meets the above criteria in more than an incidental manner. Accessory uses such as garages or workshops do not constitute noise-sensitive uses.

Based on staff's review of the submitted site plan and a 2005 aerial photograph, the 36-acre processing and storage area would be located approximately 825 feet from High Desert Middle School, the closest dust- or noise-sensitive use. However, the first building permit for the school was not issued until 1992, after the effective date of Ordinance 90-014 on July 16, 1990. Therefore, High Desert Middle School is not protected by criterion 'B' above.

The next closest dust- or noise-sensitive use is the dwelling located approximately 1,200 feet east of operations area, and identified on Assessor map 18-12-14, as tax lot 600. County records indicate a manufactured home permit (MH11036) was issued to tax lot 600 on March 11, 1991, after the effective date of Ordinance 90-014. Similar to High Desert Middle School, the dwelling on tax lot 600 is not protected by criterion 'B' above.

All other dust- and noise-sensitive uses are located over 1/4-mile (1,320 feet) from the processing and storage area. These criteria would be met.

5. Section 18.52.110, General operational standards.

Prior to the start of any surface mining activity and no later than site plan review if such review is required under this section, the applicant shall demonstrate that the following standards are or can be met by the surface mining operation:

A. Access.

1. **All on-site roads used in the mining operation, and access roads from the site to a public road maintained by a government agency, are designed and constructed to accommodate the vehicles and equipment which will use them, and shall meet the following minimum standards:**

- a. **All access roads within 100 feet of a paved county road or state highway are paved unless the applicant demonstrates that other methods of dust control, including application of**

oil or water, will be implemented in a manner which provides for the safety and maintenance of the county road or state highway.

- b. Roads within the surface mining parcel which are used as part of the surface mining operation are constructed and maintained in a manner by which all applicable DEQ standards for vehicular noise control and ambient air quality are or can be satisfied.*
- c. All roads used for mining are paved and will be adequately maintained at all points within 250 feet of a dwelling or other dust-sensitive use existing on the effective date of Ordinance No. 90-014.*

FINDING: The applicant is not proposing any changes to the access roads/driveways into the landfill site. The existing access road from 27th Street is paved to a point beyond the weigh station, exceeding the 100-foot requirement in criterion 'a' above. Within the areas of extraction, processing, and storage, the access roads are a combination of dirt and gravel. The applicant's burden of proof indicates that all unpaved roads on-site are treated for dust suppression through the application of a chemical dust suppressant or water applied by a water truck. The applicant states that the site is regulated by the DEQ through a disposal permit which includes dust and noise standards. As noted above, no dust- or noise-sensitive uses are located closer than 800 feet from the proposed operations area. These criteria would be met.

- 2. Improvements or fees in lieu of improvements of public roads, county roads and state highways may be required when the Planning Director or Hearings Body, in consultation with the appropriate road authority, determines that the increased traffic on the roads resulting from the surface mining activity will damage the road sufficiently to warrant off-site improvements. If a fee in lieu of improvements is required, the amount of the fee shall reflect the applicant's prorata share of the actual total cost of the capital expenditure of the road construction or reconstruction project necessitated by and benefiting the surface mining operation. Discounts for taxes and fees already paid for such improvements, such as road taxes for vehicles and for property already dedicated or improved, shall be applied.*

FINDING: A notice of the application was sent to the Road Department. No comment or request for road improvements was submitted.

B. Screening.

- 1. The site is screened to meet the standards specified in DCC 18.52.110(B)(2), unless one of the exceptions in DCC 18.52.110(B)(6) applies.*
- 2. Performance Standard. When screening is required by paragraph (1), it obscures the view of the screened uses from the protected uses with the methods and to the extent described in paragraph (5) below.*
- 3. Protected Uses.*

- a. *Noise-sensitive or dust-sensitive uses existing on the effective date of Ordinance No. 90-014.*
 - b. *Public parks and waysides.*
 - c. *Frontage on roads designated by the Comprehensive Plan as collectors, arterials and highways.*
 - d. *Areas zoned Landscape Management Combining.*
 - e. *Those portions of state and federal scenic waterways from which the surface mining activity is visible from the perspective of a person standing at the high water mark on either bank of the waterway.*
4. **Screened Uses.**
- a. *All equipment stored on the site.*
 - b. *All crushing and processing equipment.*
 - c. *All excavated areas except: Areas where reclamation is occurring; roadways existing on the effective date of Ordinance No. 90-014; new roadways approved as part of the site plan; material excavated to create berms; and material excavated to change the level of the mining site to an elevation which provides natural screening.*
5. **Types of Screening.**
- a. *Natural Screening. Existing vegetation or other landscape features which are located on the surface mining site within 50 feet of the boundary of the site, and which obscure the view of the screened uses from the protected uses, shall be preserved and maintained.*
 - b. *Supplied Screening. Supplied vegetative screening is screening not already existing and which is added to the site, such as hardy plant species. Plantings shall not be required to exceed either a density of six feet on center or a height of six feet at the commencement of mining. Supplied earthen screening shall consist of berms covered with earth and stabilized with ground cover.*

FINDING: As detailed in previous findings, there are several dust- and noise-sensitive uses in the vicinity of the landfill. According to county records, the closest dwellings which were existing on July 16, 1990, the effective date of Ordinance 90-014, are identified on Assessor map 18-12-14, as tax lot 400, and 18-12-15, as tax lot 200. The dwelling on tax lot 400 was established in 1974 and is located approximately 1,700 feet to the southwest. The dwelling on tax lot 200 was established in 1986 and is located approximately 1,500 feet to the south. Those two uses are considered protected uses under criterion '3.a.' above. Under criterion '3.b.' above, 27th Street would be considered a protected use because it is classified as an arterial roadway.

The existing screening on-site includes the height of the landfill areas, the fenced portion of the landfill site, and the landscaped retaining wall along 27th Street and Rickard Road. Additionally, the crusher would be located approximately 25 feet below the ground surface. For these reasons, staff finds that the processing area and related equipment would be screened to comply with criterion 'B'.

- 6. **Exceptions. Supplied screening shall not be required when and to the extent that any of the following circumstances occurs:**

- a. *The natural topography of the site offers sufficient screening to meet the performance standard in DCC 18.52.110(B)(2).*
- b. *Supplied screening cannot meet the performance standard in DCC 18.52.110(B) (2) due to topography.*
- c. *The applicant demonstrates that supplied screening cannot reliably be established or cannot survive for a 10 year period due to soil, water or climatic conditions.*
- d. *Screened uses that are visible from the protected uses will be concluded and will either be removed or reclaimed within 18 months.*
- e. *The surface miner and the owner or authorized representative of the owner of the protected use execute and record in the Deschutes County Book of Records a mitigation agreement that waives screening requirements and describes and adopts and alternate program or technique.*

FINDING: As noted above, only the dwellings on tax lots 200 and 400 are considered protected uses requiring screening. According to the applicant, the stockpile of crushed material would reach a height of approximately 20-25 feet. Given the intervening mature tree cover, staff is uncertain if the stockpile would be visible from tax lot 200. Staff finds it likely that a portion of the stockpile would be visible from tax lot 400 because there is little topographic screening available. Staff finds that no additional supplied screening of the stockpile area would be required based on the fact that supplied screening would not meet the performance standard under 18.52.110(B) due to topography.

- 7. *Continued Maintenance. Vegetative screening shall be maintained and replaced as necessary to assure the required screening throughout the duration of the mining activity.*

FINDING: The applicant does not propose any changes to the landscaped retaining wall along 27th Street and Rickard Road. The applicant shall be required to maintain this vegetative screening.

- C. *Air Quality. The discharge of contaminants and dust created by the mining operation and accessory uses to mining does not exceed any applicable DEQ ambient air quality and emissions standards.*

FINDING: The applicant has stated that the contractor providing crushing services holds a DEQ permit that would be used to comply with air quality standards. Fugitive dust is not permitted to create a nuisance. A condition of approval would require that the applicant meet all DEQ air contaminant requirements, including the air quality permit for the crusher.

- D. *Erosion Control. Sedimentation and erosion resulting from the mining operation does not affect any perennial stream so as to violate DEQ's water quality standards.*

FINDING: The applicant correctly states in the burden of proof statement that there are no perennial streams on or near the surface mining site.

- E. Streams and drainage. Unless agreed to, in writing, by the adjoining property owner(s), existing natural drainages on the site are not changed in a manner which substantially interferes with drainage patterns on adjoining property or which drains waste materials or waste water onto adjoining property or perennial streams. Where the surface mining site abuts a lake, perennial stream or other perennial body of water....**

FINDING: The applicant indicates that all surface water is managed on the site, and that no storm water from mining operations leaves the site. There are no bodies of water on the subject property.

- F. Equipment Removal. All surface mining equipment and related structures will be removed from a mining site within 30 days of completion of all mining and reclamation.**

FINDING: The applicant states that the terms of the contract with the rock crushing contractor require the timely removal of equipment upon completion of the project. This has been added as a condition of approval.

- G. Flood Plain. Any mining operations conducted in a flood plain....**

FINDING: No mapped flood plains exist on-site. Therefore, this criterion does not apply.

- H. Noise. Noise created by a mining operation, vehicles, equipment or accessory uses which is audible off the site does not exceed DEQ noise control standards, due to topography or other natural features, or by use of methods to control and minimize off-site noise, including, but not limited to: Installation of earth-berms; placing equipment below ground level; limiting hours of operation; using a size or type of vehicle or equipment which has been demonstrated to meet applicable DEQ noise control standards; relocation of access roads, and other measures customarily used in the surface mining industry to meet DEQ noise standards.**

FINDING: The proposed crushing and stockpiling operation would include vehicles and equipment that would create noise audible off of the site. The closest noise-sensitive use is High Desert Middle School, which is approximately 825 feet northwest of the proposed processing and stockpiling area. The closest dwelling to the proposed operation would be approximately 1,200 feet east. In addition, Department of Solid Waste staff indicate that a 3:1 slope must be maintained within the processing pit. As noted above, the crusher would be located approximately 25 feet below grade. Given the 3:1 slope within the pit, the crusher would be located an additional 75 feet away from the closest points of the operations area to the noise-sensitive uses identified above. Therefore, the school and dwelling would be located approximately 900 and 1,275 feet away, respectively.

The applicant has submitted a noise comparison which lists the sound level of a crusher at approximately 86 decibels (db); staff has previously found that trucks also have approximately the same db rating. Using the noise attenuation formula of $20 \log D/50$ (D = distance from mining site), and the estimated noise level of the equipment used at the site of 86 db, the expected noise level at the school would be approximately 61 dBA (20

$\log 900/50 = 25$; $86 - 25 = 61$). The expected noise level at the closest dwelling would be 58 ($20 \log 1,275/50 = 28$; $86 - 27 = 58$).

Because of variations in equipment and topography between the mining site and the dwelling site, and atmospheric conditions, the attenuation formula is considered accurate to no more than ± 2 dBA. Therefore, staff finds the resultant noise level at the school due to proposed processing and stockpiling activity to be between 63 to 59 dBA. Similarly, staff finds the resultant noise level at the closest dwelling to be between 60 to 56 dBA.

Noise generated at this mining site is required to meet the standards found in Table 7 of OAR 340-35-035, for existing industrial sources of noise. This table sets forth the L50, L10, and L1 noise levels between the hours of 7 a.m. and 10 p.m. to be 55 dBA, 60 dBA, and 75 dBA, respectively. (L50, L10, and L1 refer to the level of noise that is expected to occur during 50%, 10%, and 1% in any given hour, or 30 minutes, 6 minutes, or 36 seconds, respectively.)

Due to the type of equipment and the duration of particular phases of activity during mining, the county considers the L10 noise level for medium duration noises to be the appropriate standard to use for evaluating mining operations. The L10 standard is 60 dBA, based on the above-mentioned Table 7. As indicated above, noise can be expected to reach a level of up to 63 dBA at the school and 60 dBA at the dwelling, exceeding the 60 dBA standard. However, these values do not account for mature trees between the operations area and the noise-sensitive uses, or the fact that the crusher would be located approximately 25 feet below grade. Given these additional factors, staff finds that expected noise levels at both the school and dwelling would meet the 60 dBA standard.

I. Hours of Operation.

1. Mineral and aggregate extraction, processing and equipment operation is limited to the following operating hours:

- a. *Surface mining sites located within one-half mile of any noise-sensitive use or structure existing on the effective date of Ordinance No. 90-014: 7:00 a.m. to 6:00 p.m. - Monday through Friday and 8:00 a.m. to 5:00 p.m. - Saturday.*
- b. *All other sites: 7:00 a.m. to 10:00 p.m. - Monday through Saturday.*
- c. *No surface mining operations shall be conducted on Sundays or the following legal holidays: New Year's Day, Memorial Day, July 4th, Labor Day, Thanksgiving Day, Christmas Day.*

FINDING: The proposed processing and stockpiling activity would be located within one-half mile of noise-sensitive uses (dwellings and school), as specified in foregoing findings. The proposed hours of operation would be 7:00 a.m. to 5:00 p.m., Monday through Friday. This would comply with criterion 'a' above. The applicant's burden of proof indicates no surface mining operations would be conducted on Saturdays, Sundays or the legal holidays listed above. Compliance with the specified operating hours has been added as a condition of approval.

J. Drilling and Blasting.

1. **Drilling and blasting are allowed under the site-specific ESEE analysis in the surface mining element of the Comprehensive Plan.**
2. **Drilling and blasting which are to be conducted within one-half mile of any noise-sensitive or dust-sensitive use or structure or agricultural use involving the raising of animals meet or can meet the following standards:**
 - a. **DEQ noise standards for drilling and blasting.**
 - b. **A plan addressing the potential for flying rocks and other effects on surrounding uses has been submitted to and approved by the County.**
 - c. **Blasting shall be restricted to the hours of 9:00 a.m. to 5:00 p.m., Monday through Friday, and no blasting will occur on Saturdays, Sundays or legal holidays identified in DCC 18.52.110(I)(2).**
 - d. **A plan has been submitted to and approved by the County describing how the operator will notify the owners and inhabitants of the protected uses identified in DCC 18.52.110(J)(2), which are located within one-half mile of the blasting site of proposed blasting written notice:**
 - i. **Delivered in a manner calculated to be received by each person entitled to notice at least 48 hours prior to the time the blasting activity will occur;**
 - ii. **Containing a statement providing that the recipient property owner must provide the notice to tenants and inhabitants on the subject property.**
 - iii. **In the case of ongoing blasting, given at least once each month and specifying the days and hours that blasting will occur; and**
 - iv. **Retained by the operator, along with a list of persons notified, for at least one year after blasting occurs.**

FINDING: The applicant is proposing drilling and blasting as part of this application. The DEQ standards for noise must be met by the contractor hired by the applicant for the drilling and blasting. The applicant has stated that the contractor for the crushing is required to submit a plan for earth movement, flying rocks or other effects on surrounding uses. Drilling and blasting Blasting would be limited to the hours of 9:00 a.m. to 5:00 p.m., Monday through Friday, as outlined above. The applicant would be required to send the notice specified under item 'd' above, and keep records for at least one year after the blasting occurs. These would be made conditions of approval.

L. Fish and Wildlife Protection.

1. **Fish and wildlife values and habitat required by the site specific ESEE analysis to be conserved and protected are conserved and protected by use of methods including, but not limited to: Seasonal operations and access road closures; retention of or creation of vegetative cover and riparian habitat; and erection of fencing or other barriers to protect wildlife from steep extraction site slopes.**
2. **Mitigation, as defined in this title, will be provided to compensate for any loss of fish and wildlife habitat caused by the surface mining activity which habitat is required to be protected by the site-specific ESEE analysis. When mitigation is provided, the type and**

effectiveness of mitigation required has been determined by the Planning Director or Hearings Body to be appropriate from available evidence and in consultation with the Oregon Department of Fish and Wildlife.

FINDING: The subject property has no identified fish and wildlife values or habitat in the County comprehensive plan. No mitigation is required.

- M. *Surface water management is provided in a manner which meets all applicable DEQ water quality standards and DOGAMI requirements, and which demonstrates that all water necessary for the proposed operation of the surface mine, including dust control, landscaping and processing of material, has been appropriated to the surface mining site and is legally available for such use. The applicant must provide written documentation of any water rights from the respective water district and Oregon Watermaster's office prior to any mining of the site.***

FINDING: The applicant states that surface water management for the mining site falls within the surface water management requirements of the Solid Waste Department's DEQ disposal permit. According to the applicant, water is provided on the site by Avion Water Company, and this water can be used for dust control, landscaping or processing of the material.

- N. *Storage of equipment, structures and other materials at the site is limited to that which is necessary and appurtenant to the mining operation or other uses permitted on the site.***

FINDING: The applicant states that only mining-related equipment would be stored at the site for the crushing and storage of the material.

- O. *A security plan for the subject site has been submitted and approved by the county and, where appropriate, by DOGAMI which addresses the following issues:***
- 1. lighting;***
 - 2. fencing;***
 - 3. gates at access points;***
 - 4. water impoundments;***
 - 5. sloping; and***
 - 6. security of vehicles and equipment***

FINDING: The applicant states that all proposed operations would take place in the landfill compound, which is enclosed with a 6-foot-tall chain link fence, and which has gates at access points that are locked during non-business hours. The only lighting on the site is exterior lights on existing buildings. Staff finds that the site would meet this criterion.

- P. *All impacts of the mining activities identified in the ESEE analysis for the specific site are addressed and have been resolved at the time of site plan approval or before the start of mining activity.***

FINDING: The specific requirements established in the "Program to Meet the Goal" section of the ESEE analysis (pages 8, 9) for SM Site no. 390 are as follows:

- a. *Setbacks shall be required for potential conflicting residential and other development;*
- b. *Noise and visual impacts shall be mitigated by buffering and screening;*
- c. *Processing operations and equipment shall be placed at a location on the site that will permit such activity to operate within DEQ noise and dust requirements;*
- d. *Use of vehicles in the extraction, processing, and transportation of the material shall meet the DEQ noise level requirements.*

The Board finds that processing on the site will be allowed.

Previous findings detail how each of the above-referenced criteria would be met.

6. Section 18.52.140. Conditional use criteria.

The criteria set forth in this section shall be the only conditional use criteria applicable to the surface mining activities described below. Compliance with these criteria shall be demonstrated at the time of site plan review.

- A. *Crushing.*** *When a site has been designated for crushing of mineral and aggregate materials under the site-specific ESEE analysis in the surface mining element of the Comprehensive Plan, the following conditions apply:*
1. *If a crusher is to be located less than one-half mile from a noise-sensitive use or structure existing on the effective date of Ordinance 90-014, the applicant shall demonstrate through a noise report from a qualified, registered sound engineer or similarly qualified professional, that the crusher can meet all applicable DEQ industrial and commercial noise control standards as designed and located, or by methods including, but not limited to: Modification or muffling of the crusher; placement of the crusher below grade or behind berms.*
 2. *If a crusher is to remain on the site for longer than 60 days in any 18-month period, the applicant shall demonstrate that it will be screened in accordance with DCC 18.52.110(B).*

FINDING: The proposed crusher would be located a minimum of 1,500 feet from the closest noise-sensitive use, which is a dwelling identified on Assessor map 18-12-15, as tax lot 400. A noise analysis was made by staff in a foregoing finding and the operation was determined to meet DEQ noise standards taking into consideration intervening mature trees and the location of the crusher approximately 25 feet below grade. It is anticipated that the crusher may be on-site for longer than 60 days in any 18-month period. With the existing screening from topography, fencing, retaining wall and landscaping, staff finds that the crusher would be screened according to section 18.52.110(B).

IV. CONCLUSION:

Staff finds the applicant can meet all of the required approval criteria. The conditional use permit and site plan review are **APPROVED**, subject to the conditions of approval listed below.

V. RECOMMENDED CONDITIONS OF APPROVAL:

1. This approval is based upon the site plan and information submitted by the applicant. Any substantial change in the approved plan would require a new application.
2. The applicant shall follow and meet all requirements of the site-specific ESEE analysis.
3. Any dust and noise created from the mining operation and associated activities at this site shall be controlled so as to meet applicable DEQ standards, and in such a manner as not to be a nuisance as defined in OAR 340-21-050. Watering or chemical treatment of the roads on the site used for access shall be required where deemed necessary to prevent a nuisance. The access roads shall be maintained for safety.
4. All mining operations shall be conducted between the hours of 7:00 a.m. and 5:00 p.m., Monday through Friday. No surface mining operations shall be conducted on Saturdays, Sundays or the following legal holidays: New Year's Day, Memorial Day, July 4th, Labor Day, Thanksgiving Day, Christmas Day.
5. ~~Drilling and blasting~~ Blasting to excavate the materials shall only be allowed between the hours of 9:00 a.m. to 5:00 p.m., Monday through Friday. The applicant shall send the required notice under section 18.52.110(J)(2)(d) for the drilling and blasting.
6. Any exterior lighting used for the surface mining operation shall meet all requirements of Chapter 15.10, Outdoor Lighting, of the Deschutes County Code.
7. The applicant (or contractor) shall obtain an Air Contaminate Discharge Permit from the Oregon Department of Environmental Quality, and submit a copy to the Planning Division, prior to commencement of any crushing on the site. The rock crusher shall be located below natural ground level to reduce the amount of noise generated from the site, as specified on the submitted plan.
8. The existing topographic and vegetative screening for the surface mine shall be maintained and/or replaced to assure screening throughout the duration of the crushing operation.
9. Only equipment, structures and materials related to proposed surface mining shall be allowed on the surface mining site. All surface mining equipment and related structures shall be removed from the site within 30 days of completion of all mining and reclamation.
10. No on-site sales of excavated or crushed material shall be allowed for the site.

VII. DURATION OF APPROVAL:

The applicant shall initiate the use within two (2) years following the date this decision becomes final or obtain an extension of time pursuant to Section 22.36.010 of the County Code, or this approval shall be void.

This decision becomes final twelve (12) days from the date of this mailing unless appealed by a party of interest.

DESCHUTES COUNTY PLANNING DIVISION



Written by: Anthony Raguine, Senior Planner

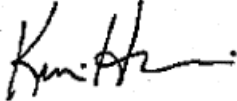

Reviewed by: Kevin M. Harrison, Acting Planning Director

Dated this 2nd day of October, 2008

Mailed this 2nd day of October, 2008

AJR/slb

PART VII
PROJECT DRAWINGS



Knott Landfill Compost Relocation Project
Site Plan

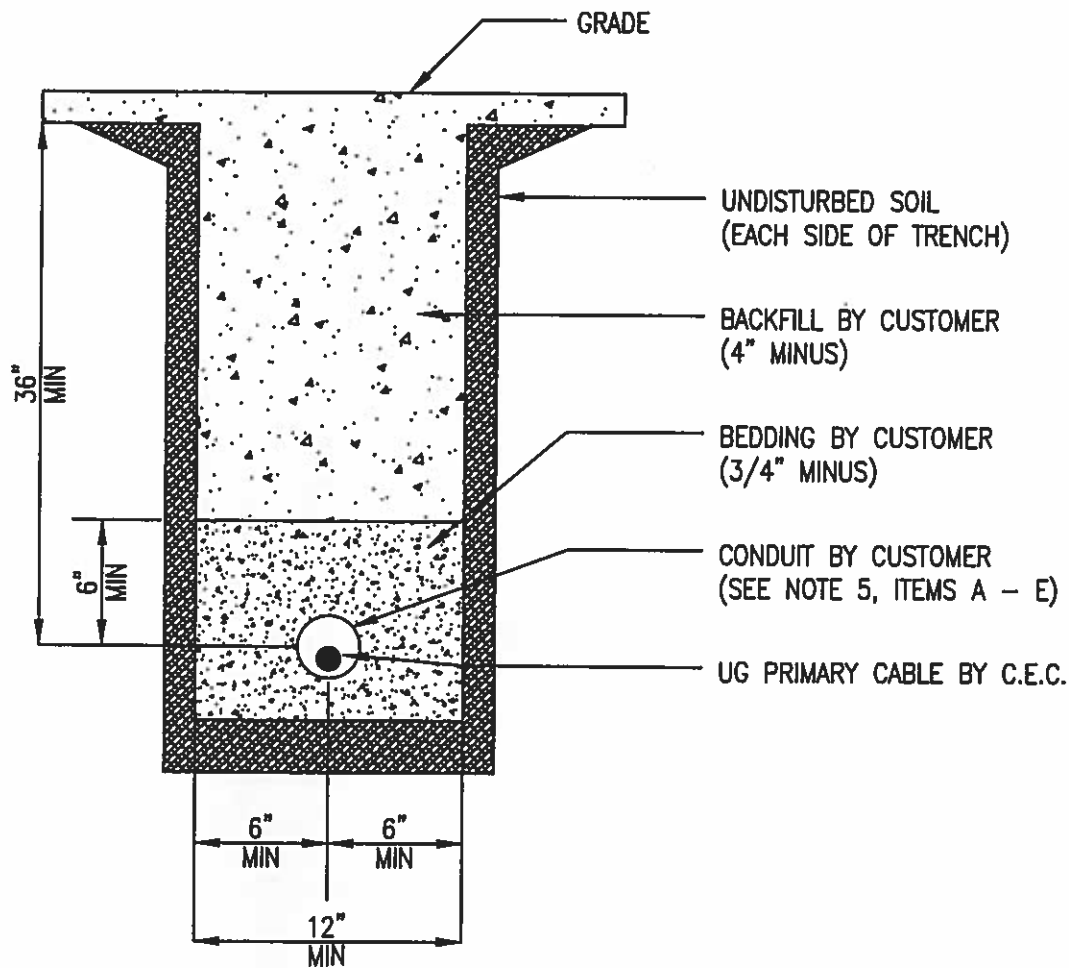

NOTES:

1. CUSTOMER TO TRENCH ON THEIR PROPERTY AS DESIGNATED BY C.E.C.
2. TRENCH BOTTOM SHALL BE FLAT AND LEVEL WITH NO SHARP ROCK PROJECTIONS.
3. MINIMUM OF ONE FOOT SEPERATION REQUIRED BETWEEN C.E.C. CABLE AND OTHER UNDERGRUOND UTILITIES.
4. C.E.C. TO INSPECT WHEN TRENCH IS READY (BEFORE BACKFILLING).
5. CONDUIT TO BE INSTALLED:
 - A. USE ONLY GRAY UL APPROVED SCHEDULE 40 PVC OR RIGID STEEL.
 - B. GLUE ALL PVC CONDUIT JOINTS TOGETHER WITH CORRECT PVC GLUE.
 - C. INSTALL A CONTINUOUS (NO KNOTS) 1/4 INCH DIAMETER TWISTED BRAID POLYPROPYLENE PULL ROPE THROUGH CONDUIT RUN.
 - D. DIAMETER OF CONDUIT TO BE SPECIFIED BY C.E.C.
 - E. ONLY SCHEDULE 40 PVC FITTINGS WILL BE ALLOWED. NO WHITE PVC OR BLACK ABS.
6. COMPACTION OF BACKFILL UNDER ROADS AS REQUIRED BY CITY, COUNTY, OR STATE REGULATIONS.
7. C.E.C. RESERVES THE RIGHT TO REJECT ANY TRENCH NOT MEETING THESE SPECIFICATIONS.

APPROVALS:

ENGINEER:

PURCHASING:

GENERAL FOREMAN:



CENTRAL ELECTRIC
COOPERATIVE, INC.

UG PRIMARY
IN CONDUIT

REV. DATE:

SHEET 6 OF

DRAWING NUMBER:

UG-110

REV.#

| REV. | REVISION | DATE | BY |
|------|--------------------------------|---------|-----|
| A | ADD 3/4" HOLES FOR GROUND WIRE | 7-24-03 | JPM |

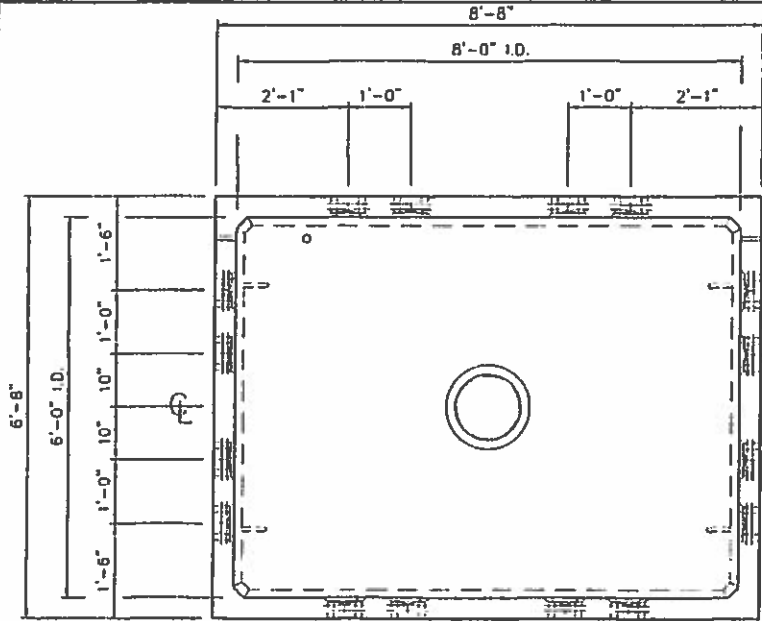

PLAN

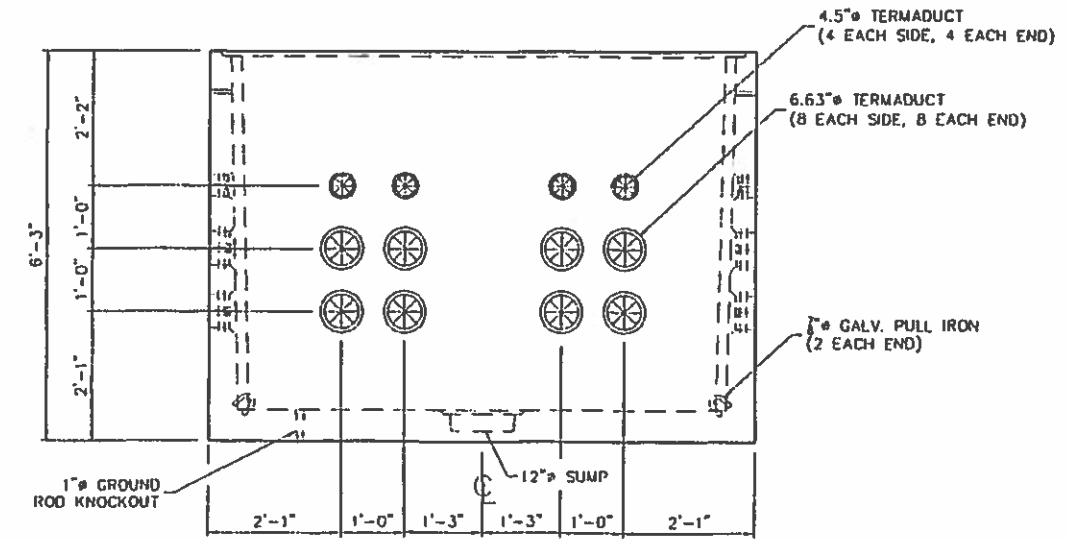

SIDE

STRUCTURAL NOTES

1. CONCRETE: 28 DAY COMPRESSIVE STRENGTH $f'_c = 5,500$ PSI
2. REBAR: ASTM A-615 GRADE 60
3. MESH: ASTM A-185 GRADE 63
4. DESIGN: ACI-318 BUILDING CODE
ASTM C-857 "MIN. STRUCTURAL DESIGN LOADING FOR UNDERGROUND PRECAST CONCRETE UTILITY STRUCTURES"
5. LOADS: H-20 TRUCK WHEEL W/ 30% IMPACT
AASHTO LIVE LOAD SURCHARGE (2 FT. SOIL)
MAXIMUM SOIL COVER 5 FT.
WATERTABLE AT 5 FT. BELOW GRADE
40 PCF LATERAL SOIL PRESSURE ABOVE WATERTABLE
80 PCF LATERAL SOIL PRESSURE BELOW WATERTABLE

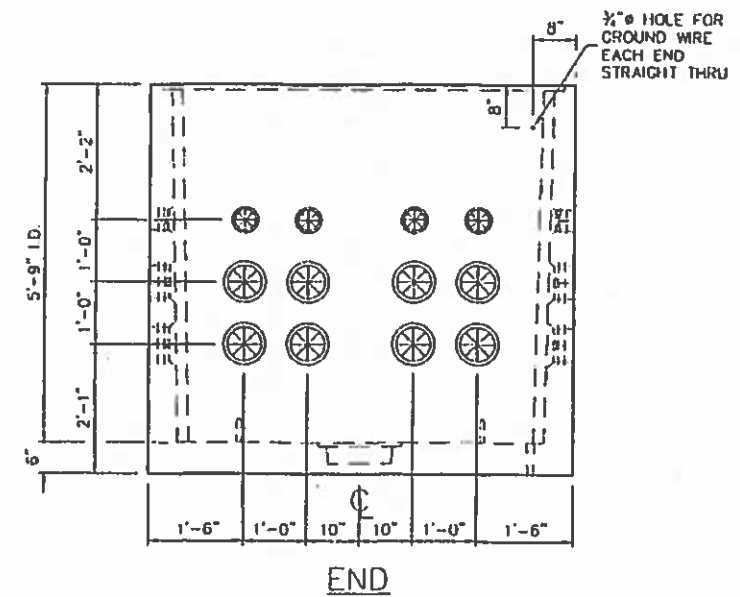

END

VAULT C2

| PART | DESCRIPTION | QTY. | SIZE | REV. |
|----------------------------|-------------|------|------|------|
| BILL OF MATERIAL | | | | |
| CENTRAL ELECTRIC CO-OP | | | | |
| U.V. MODEL #587-2-CEC BASE | | | | |

| | | | |
|-------------|-----|-------|---------|
| DRAWN | ATT | DATE | 4-16-03 |
| CHECKED | | SCALE | 3/4"=1' |
| SALESPERSON | | SHEET | OF |

| | | | | | | | |
|-----------|----------|------------|--|-------------|--|------|--|
| S.O. # | Standard | SP. LINE # | | ONE NO. | | REV. | |
| CURT. CEC | | | | C687-2B-CEC | | A | |

THIS DRAWING IS THE PROPERTY OF OLDCASTLE PRECAST INC. IF IT IS REPRODUCED FOR ANY PURPOSES WITHOUT THE WRITTEN PERMISSION OF OLDCASTLE PRECAST INC. IT IS TO BE DESTROYED AT THE REQUEST OF OLDCASTLE PRECAST INC. IN WRITING.

Oldcastle Precast
Utility Vault
PO Box 373 Wilsonville, OR 97070
(503) 682-2844 Fax (503) 682-2657

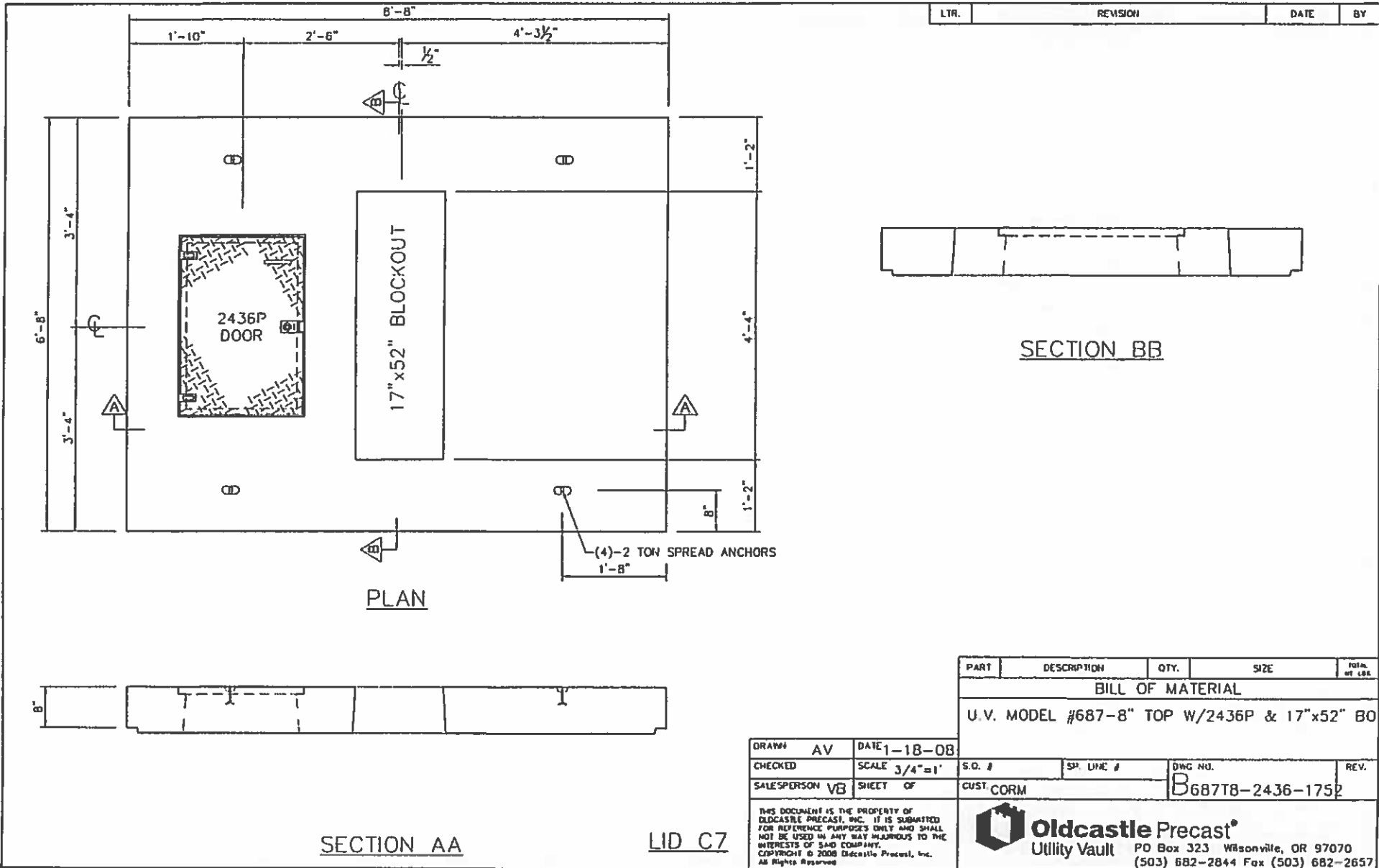

| | | | |
|------|----------|------|----|
| LTR. | REVISION | DATE | BY |
|------|----------|------|----|

PLAN

SECTION BB

SECTION AA

LID C7

| PART | DESCRIPTION | QTY. | SIZE | TOTAL OF LBS. |
|------|-------------|------|------|------------------|
|------|-------------|------|------|------------------|

BILL OF MATERIAL

U.V. MODEL #687-8" TOP W/2436P & 17"x52" BO

| | | | | | |
|----------------|---------------|------------|------------|------------------|------|
| DRAWN AV | DATE 1-18-08 | S.O. # | SP. LINE # | DWG NO. | REV. |
| CHECKED | SCALE 3/4"=1' | CUST. CORM | | B687T8-2436-1752 | |
| SALESPERSON VB | SHEET OF | | | | |

THIS DOCUMENT IS THE PROPERTY OF OLDCASTLE PRECAST, INC. IT IS SUBMITTED FOR REFERENCE PURPOSES ONLY AND SHALL NOT BE USED IN ANY WAY INJURIOUS TO THE INTERESTS OF SAID COMPANY. COPYRIGHT © 2008 Oldcastle Precast, Inc. All Rights Reserved.

Oldcastle Precast
 Utility Vault PO Box 323 Wilsonville, OR 97070
 (503) 682-2844 Fax (503) 682-2657

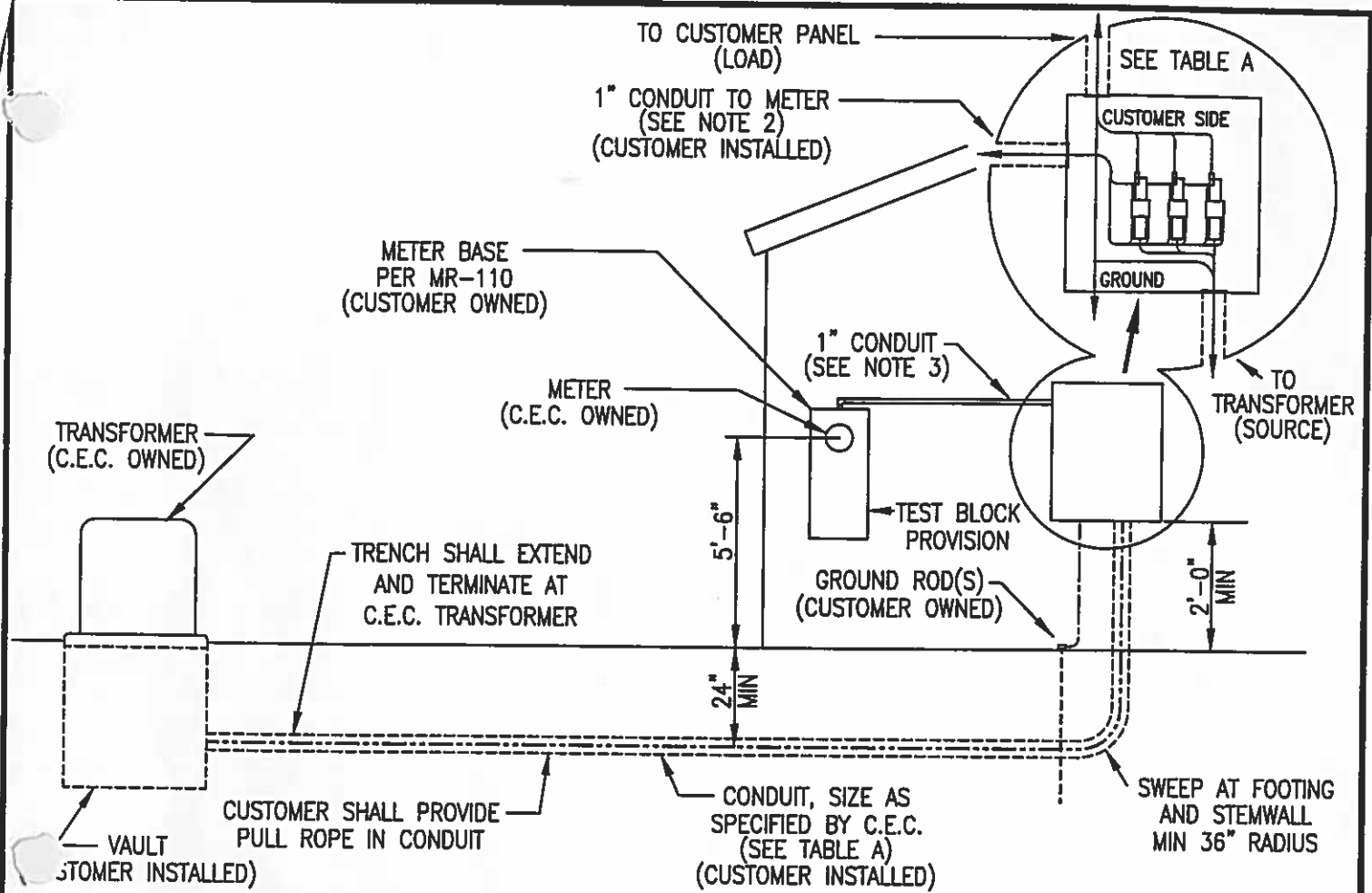

| MAIN SERVICE RATING AMP | TABLE A | | | MINIMUM RECOMMENDED CT CABINET SIZE | |
|-------------------------|----------------------|------------------------------|--------------|-------------------------------------|-----------|
| | MINIMUM CONDUIT SIZE | MAXIMUM CABLE SIZE PER PHASE | | | |
| | 3 - WIRE | 4 - WIRE | 3-PHASE | 1 ϕ | |
| 101 - 200 | (1) - 3" | (1) - 3" | 1 - 4/0 AWG | NOT REQ | NOT REQ |
| 201 - 400 | (1) - 4" | (1) - 4" | 1 - 750 KCM | 36" x 48" | NOT REQ |
| 401 - 600 | (2) - 4" | (2) - 4" | 2 - 750 KCM | 36" x 48" | 24" x 48" |
| 601 - 800 | (2) - 4" | (2) - 4" | 2 - 750 KCM | 36" x 48" | 36" x 48" |
| 801 - 1000 | (3) - 4" | (3) - 4" | 3 - 750 KCM | 48" x 48" | 36" x 48" |
| 1001 - 1200 | (3) - 4" | (3) - 6" | 3 - 1000 KCM | BUS MOUNT | 36" x 48" |

NOTES:

1. REFER TO TABLE "A" FOR STANDARD CT CABINET DIMENSIONS OR CONTACT C.E.C. APPROVAL BY C.E.C. MUST BE ISSUED FOR NON-STANDARD INSTALLATION. CT CABINET AND METER BASE SUPPLIED BY CUSTOMER.
2. C.E.C. WILL PROVIDE AND INSTALL METER TEST SWITCH WITH ITS ASSOCIATED WIRING BETWEEN METER BASE AND CT CABINET.
3. MAXIMUM 20' FROM CT CABINET TO METER BASE.
4. C.E.C. PROVIDES CT'S (TO BE INSTALLED BY CUSTOMER.)
5. CUSTOMER TO TERMINATE ON LOAD SIDE OF CT.
6. 601 - 1200 AMP CT'S REQUIRE A MOUNTING BASE (BY CUSTOMER.)

APPROVALS:
 ENGINEER:
 PURCHASING:
 GENERAL FOREMAN:

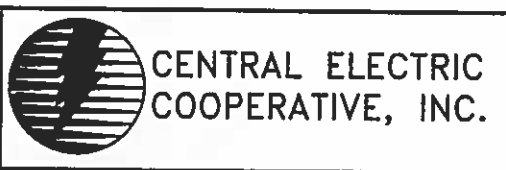

TYPICAL THREE PHASE
 METERING
 INSTALLATION

REV. DATE: DATE
 SHEET OF
 DRAWING NUMBER: SR-130
 REV.#

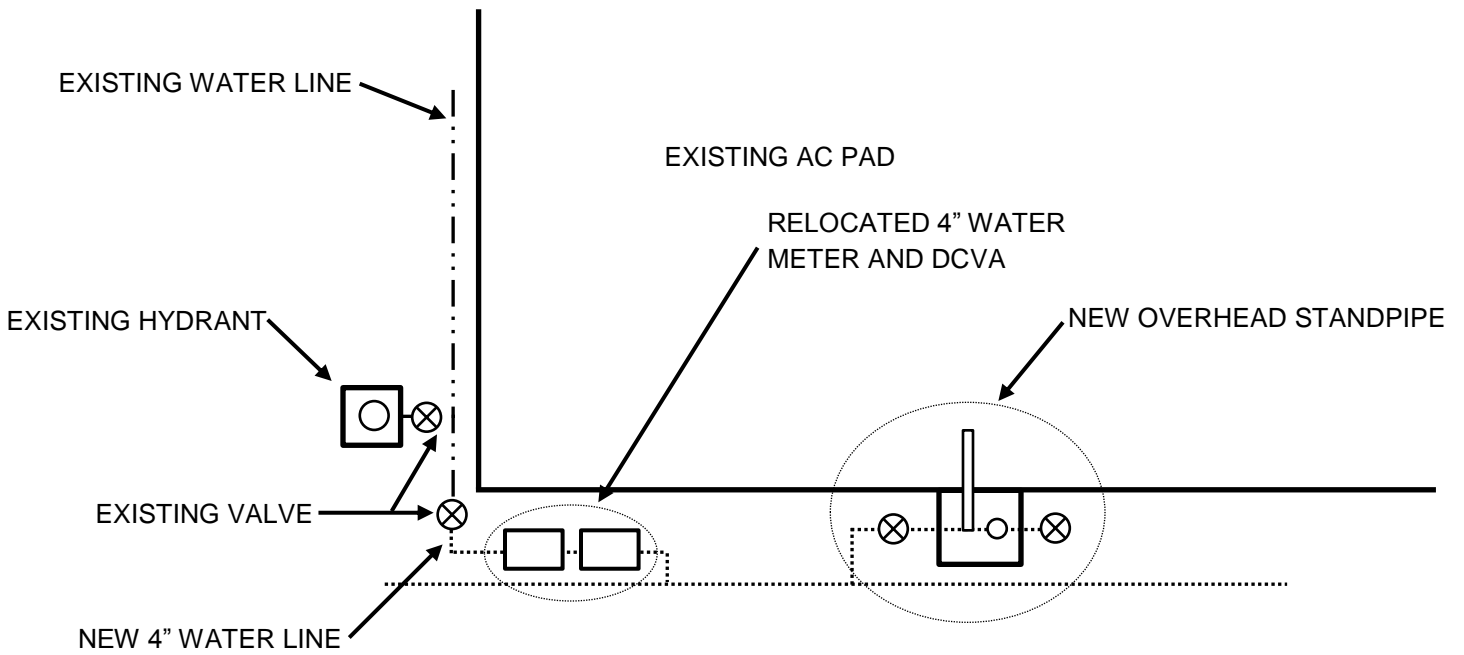

WATER SERVICE AND OVERHEAD STANDPIPE CONFIGURATION (NTS)

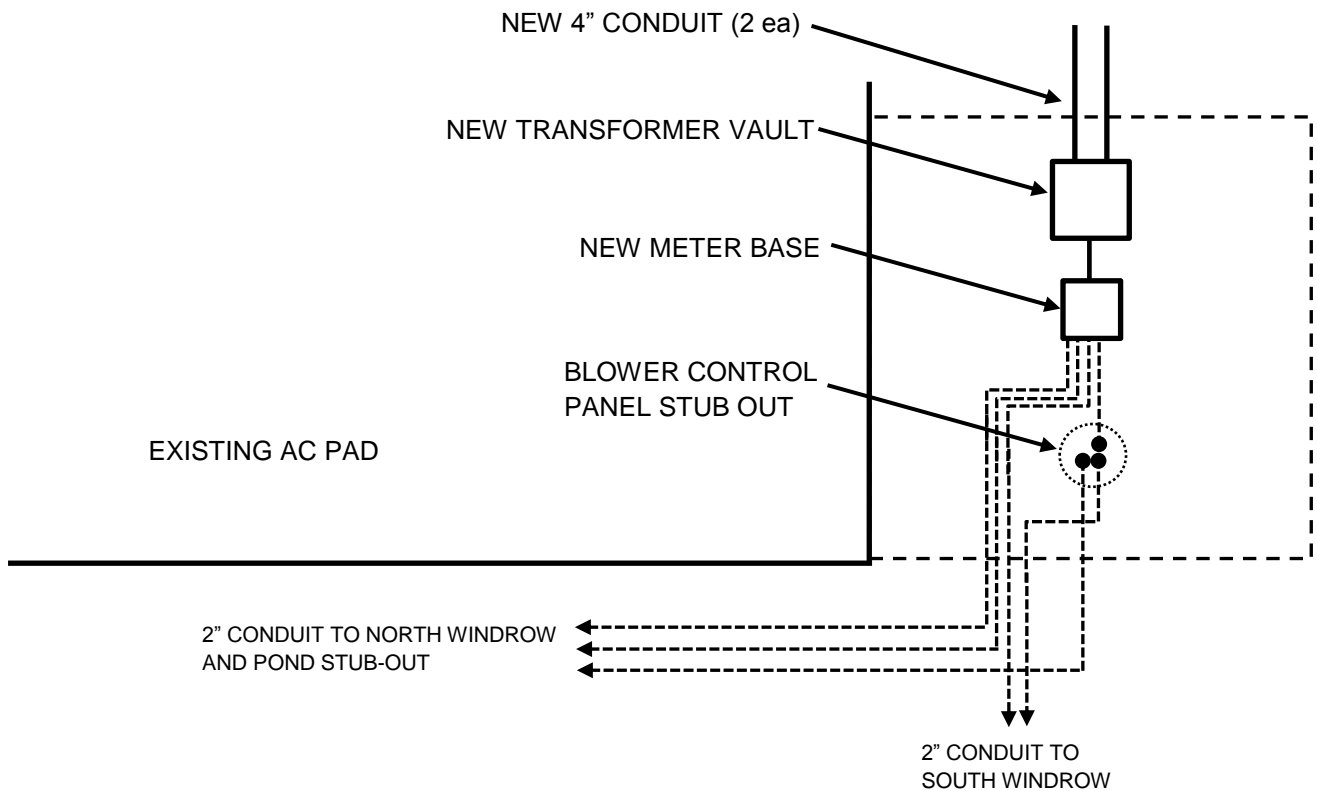

ELECTRICAL SYSTEM CONFIGURATION (NTS)

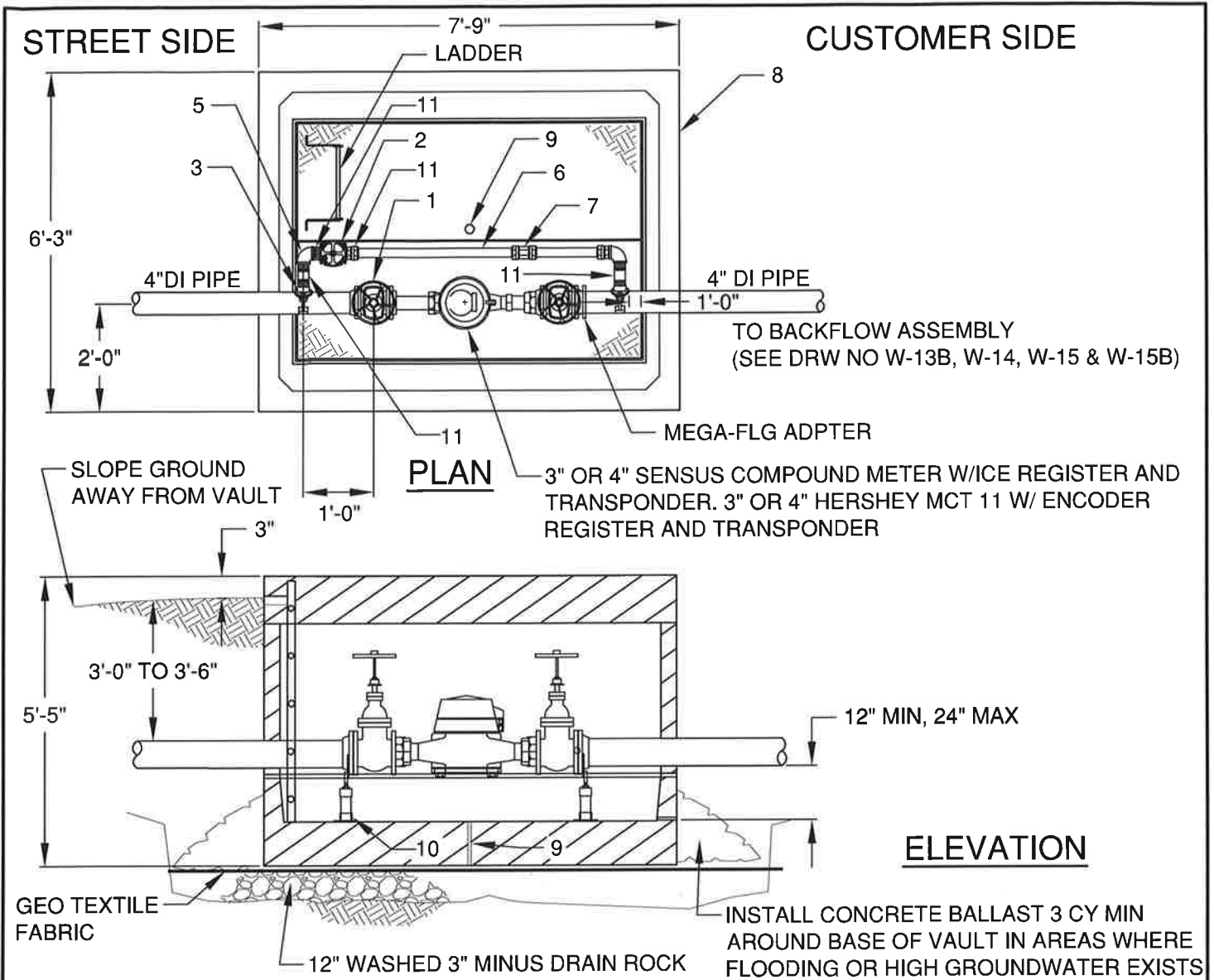

| ITEM | QTY | DESCRIPTION |
|------|-----|---|
| 1 | 2EA | 4"x3" FLG x FLG REDUCER & 3" FLG GATE VALVE WITH HANDWHEEL OR |
| 2 | 1 | 4"x4" FLG GATE VALVE WITH HANDWHEEL |
| 2 | 1 | 2" SE GATE VALVE AWWA C509 |
| 3 | 2 | DOUBLE STRAP DR-25 SERVICE SADDLE, MUELLER OR APPROVED EQUAL |
| 5 | 2 | 2" BRASS 90° COMP x COMP |
| 6 | 2 | 2" TYPE K HARD COPPER PIPE |
| 7 | 1 | 2" COMP UNION |
| 8 | 1 | UTILITY VAULT 675-WA-730 WITH OPENING FOR BILCO DOOR JD-3AL AND OSHA APPROVED LADDER (SEE DRW NO W-6) |
| 9 | 1 | WEEP HOLE |
| 10 | 2 | 2" PIPE STAND "STANDON" |
| 11 | 4 | 2" MPT x COMP ADAPTER |

- NOTES:**
1. SEAL ALL OPENINGS IN VAULT WITH NON SHRINK GROUT
 2. CONTRACTOR TO BRING ERT'S TO PUBLIC WORKS FOR INSTALLATION AND INSPECTION
 3. ENGINEER TO PROVIDE PIPE RESTRAINT DETAIL ENTERING & EXITING VAULT

| | | |
|-----------|------|------|
| DRAWN | | |
| DIV WATER | | |
| REV | DATE | APPR |
| | | |



CITY OF BEND
 STANDARDS AND SPECIFICATIONS
 710 NW WALL ST., BEND, OREGON 97701

3" & 4" COMMERCIAL METER INSTALLATION

| |
|----------------|
| SCALE NTS |
| DATE 06/5/2009 |
| APPR |
| DRW NO W-5B |

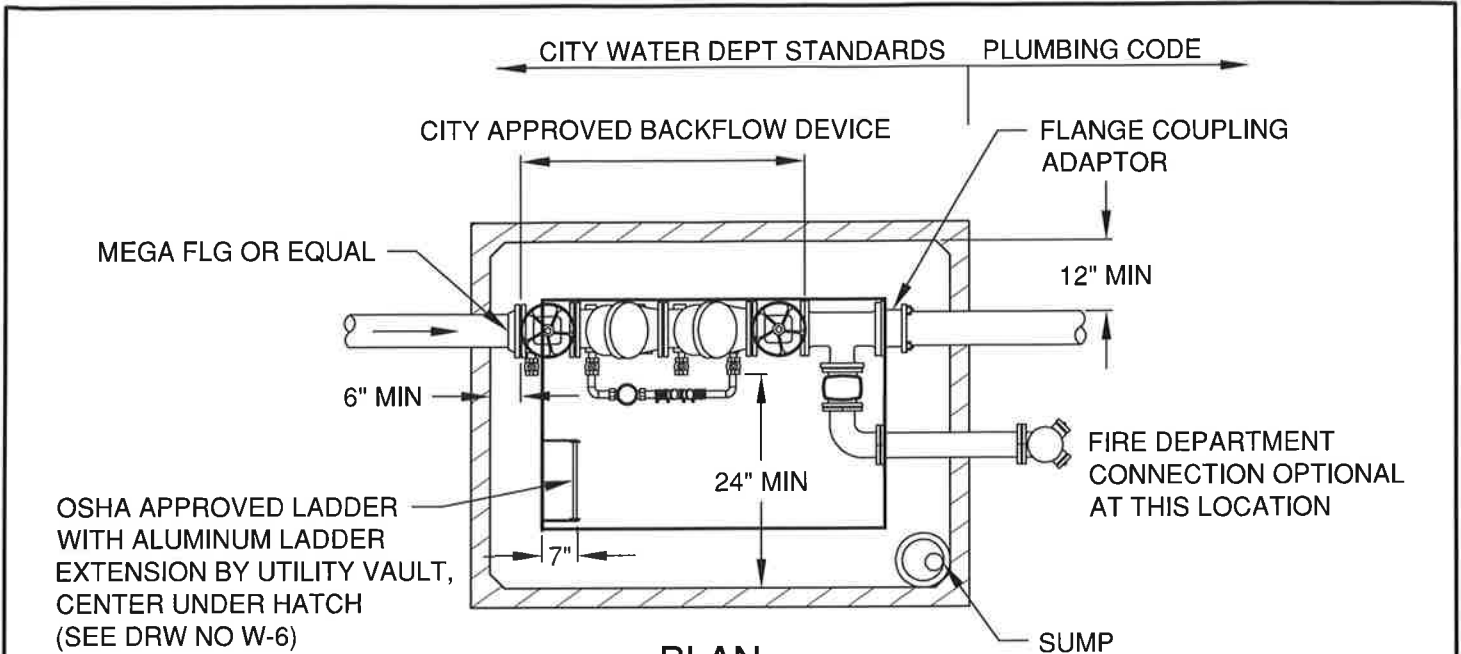

PLAN

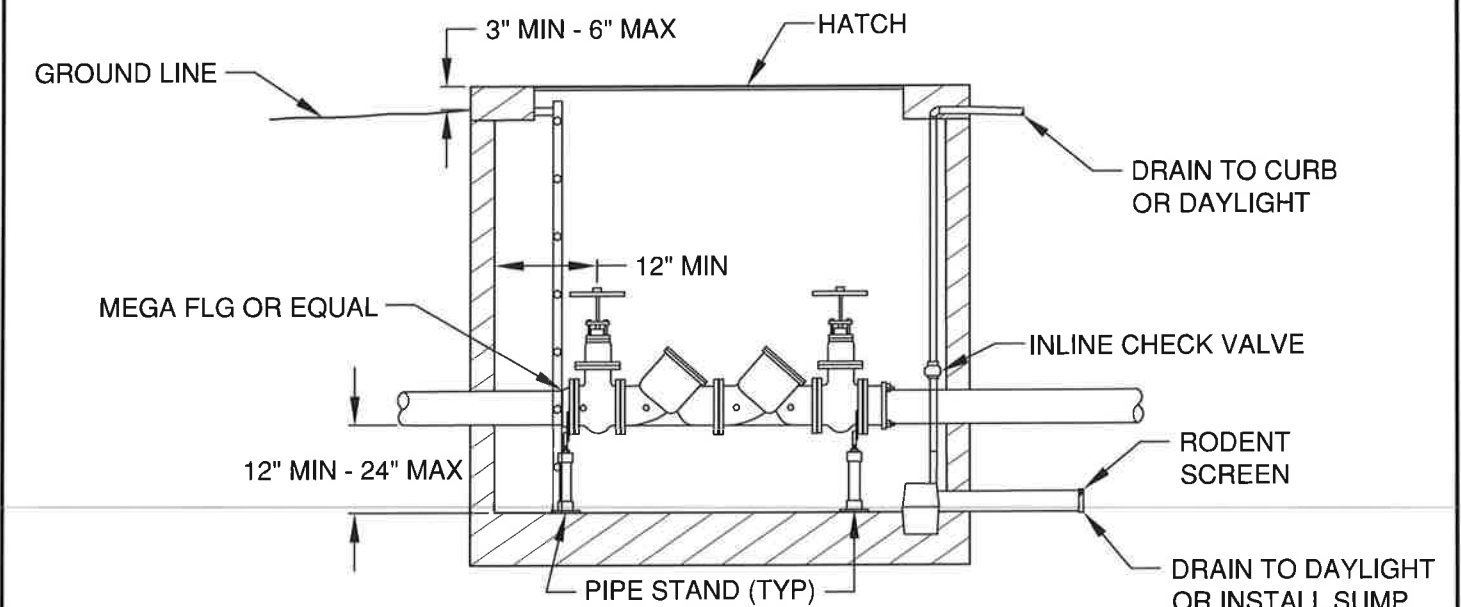

ELEVATION

FIRE VAULT MODEL

| PIPE SIZE | UTILITY VAULT OR EQUAL WITH FDC | UTILITY VAULT OR EQUAL WITHOUT FDC | BILCO DOOR OR *EQUAL |
|-----------|---------------------------------|------------------------------------|----------------------|
| 3 | | 660-WA | J-5AL |
| 4 | 676-WA | 577-WA | J-5AL |
| 6 | 687-WA | 676-WA | J-5AL |
| 8 | 5106-LA | 687-WA | JD-3AL |
| 10 | 5106-LA | 5106-LA | JD-3AL |

NOTES:

- ENGINEER TO PROVIDE RESTRAIN DETAIL FOR ALL PIPE ENTERING & EXITING VAULT
- CONTRACTOR TO SEAL ALL OPENINGS IN VAULT WITH NON-SHRINK GROUT PRIOR TO BACKFILLING

| | | |
|-----------|------|------|
| DRAWN | | |
| DIV WATER | | |
| REV | DATE | APPR |
| | | |



CITY OF BEND
STANDARD DRAWING

710 NW WALL ST., BEND, OREGON 97701

2" & LARGER DOUBLE CHECK VALVE ASSEMBLY

| |
|----------------|
| SCALE NTS |
| DATE 06/5/2009 |
| APPR |
| STD DWG W-13B |

| (HORIZONTAL) BEARING AREA OF THRUST BLOCKS IN SQUARE FEET | | | | | | | | (VERTICAL) VOLUME OF THRUST BLOCK IN CUBIC YARDS | | | | |
|---|-----------------------|-------------------|------------------------------|--------------------------|------|-------------|-----------------|--|-------------|-------------|-----------------|-----------------|
| FITTING SIZE | TEE, WYE, DEAD END | STRADDLE BLOCK | 90° BEND PLUGGED CROSS | TEE PLUGGED ON RUN | | 45° BEND | 22-1/2° BEND | 11-1/4° BEND | 90° BEND | 45° BEND | 22-1/2° BEND | 11-1/4° BEND |
| | | | | A-1 | A-2 | | | | | | | |
| 4 | 1.0 | 1.6 | 1.4 | 1.9 | 1.4 | 1.0 | --- | --- | --- | --- | --- | --- |
| 6 | 2.1 | 3.7 | 3.0 | 4.3 | 3.0 | 1.6 | 1.0 | --- | 1.3 | --- | --- | --- |
| 8 | 3.8 | 6.5 | 5.3 | 7.6 | 5.4 | 2.9 | 1.5 | 1.0 | 2.3 | 1.1 | --- | --- |
| 10 | 5.9 | 10.2 | 8.4 | 11.8 | 8.4 | 4.6 | 2.4 | 1.2 | 3.7 | 1.8 | --- | --- |
| 12 | 8.5 | 14.7 | 12.0 | 17.0 | 12.0 | 6.6 | 3.4 | 1.7 | 5.5 | 2.8 | 1.2 | --- |
| 14 | 11.5 | --- | 16.3 | 23.0 | 16.3 | 8.9 | 4.6 | 2.3 | 7.6 | 3.9 | 1.7 | --- |
| 16 | 15.0 | 26.1 | 21.3 | 30.0 | 21.3 | 11.6 | 6.0 | 3.0 | 9.9 | 5.1 | 2.3 | 0.9 |
| 18 | 19.0 | --- | 27.0 | 38.0 | 27.0 | 14.6 | 7.6 | 3.8 | --- | --- | --- | --- |
| 20 | 23.5 | 40.8 | 33.3 | 47.0 | 33.3 | 18.1 | 9.4 | 4.7 | --- | --- | --- | --- |
| 24 | 34.0 | 58.8 | 48.0 | 68.0 | 48.0 | 26.2 | 13.6 | 6.8 | --- | --- | --- | --- |

NOTES:

- ABOVE BEARING AREAS BASED ON TEST PRESSURE OF 150 PSI AND AN ALLOWABLE SOIL BEARING STRESS OF 2000 POUNDS PER SQUARE FOOT. TO COMPUTE BEARING AREAS FOR DIFFERENT TEST PRESSURES AND SOIL BEARING STRESSES, USE THE FOLLOWING EQUATION:

$$\text{BEARING AREA} = (\text{TEST PRESSURE} / 150) \times (2000 / \text{SOIL BEARING STRESS}) \times (\text{TABLE VALUE})$$
- ABOVE VOLUMES BASED ON TEST PRESSURE OF 150 PSI AND THE WEIGHT OF CONCRETE = 4050 POUNDS PER CUBIC YARD. TO COMPUTE FOR DIFFERENT TEST PRESSURES, USE THE FOLLOWING EQUATION:

$$\text{VOLUME} = (\text{TEST PRESSURE} / 150) \times (\text{TABLE VALUE})$$

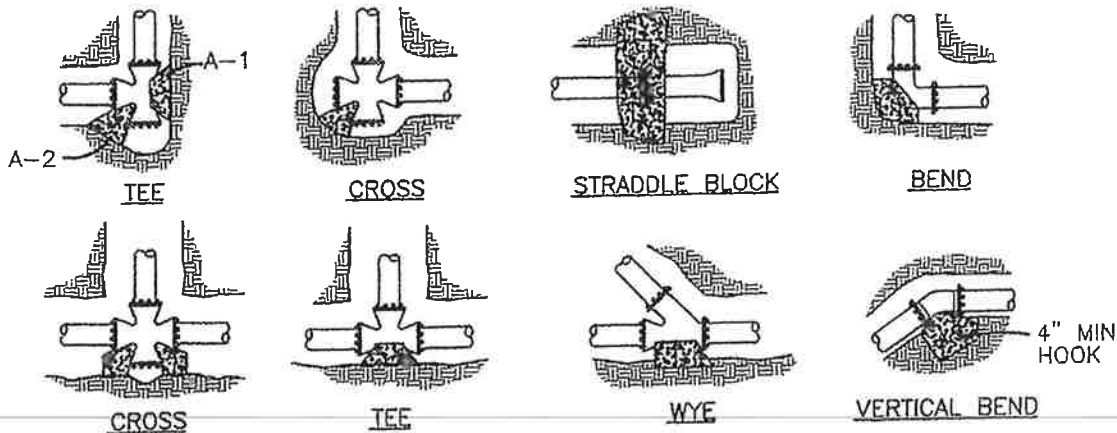

NOTES:

- CONCRETE BLOCKING TO BE POURED AGAINST UNDISTURBED EARTH.
- ALL CONCRETE TO BE CLASS 2400 MINIMUM.
- INSTALL ISOLATION MATERIAL BETWEEN PIPE AND/OR FITTINGS BEFORE POURING CONCRETE BLOCKING.
- CONCRETE SHALL BE KEPT CLEAR OF ALL JOINTS AND ACCESSORIES.
- TIE RODS SHALL BE GALVANIZED "ALL THREAD" ROD OF EITHER ASTM A242 OR A36 STEEL.

| RODS FOR VERTICAL BENDS | | |
|-------------------------|----------|-----------|
| FITTING SIZE | ROD SIZE | EMBEDMENT |
| 12" AND LESS | #6 | 30" |
| 14"-16" | #8 | 36" |

THRUST BLOCKING

N.T.S.

KNOTT LANDFILL COMPOST RELOCATON PROJECT

DESCHUTES COUNTY DEPARTMENT OF SOLID WASTE
LOCATED IN THE SECTION 14, TOWNSHIP 18 SOUTH,
RANGE 12 EAST, OF THE WILLAMETTE MERIDIAN
DESCHUTES COUNTY, OREGON
MARCH 01, 2016

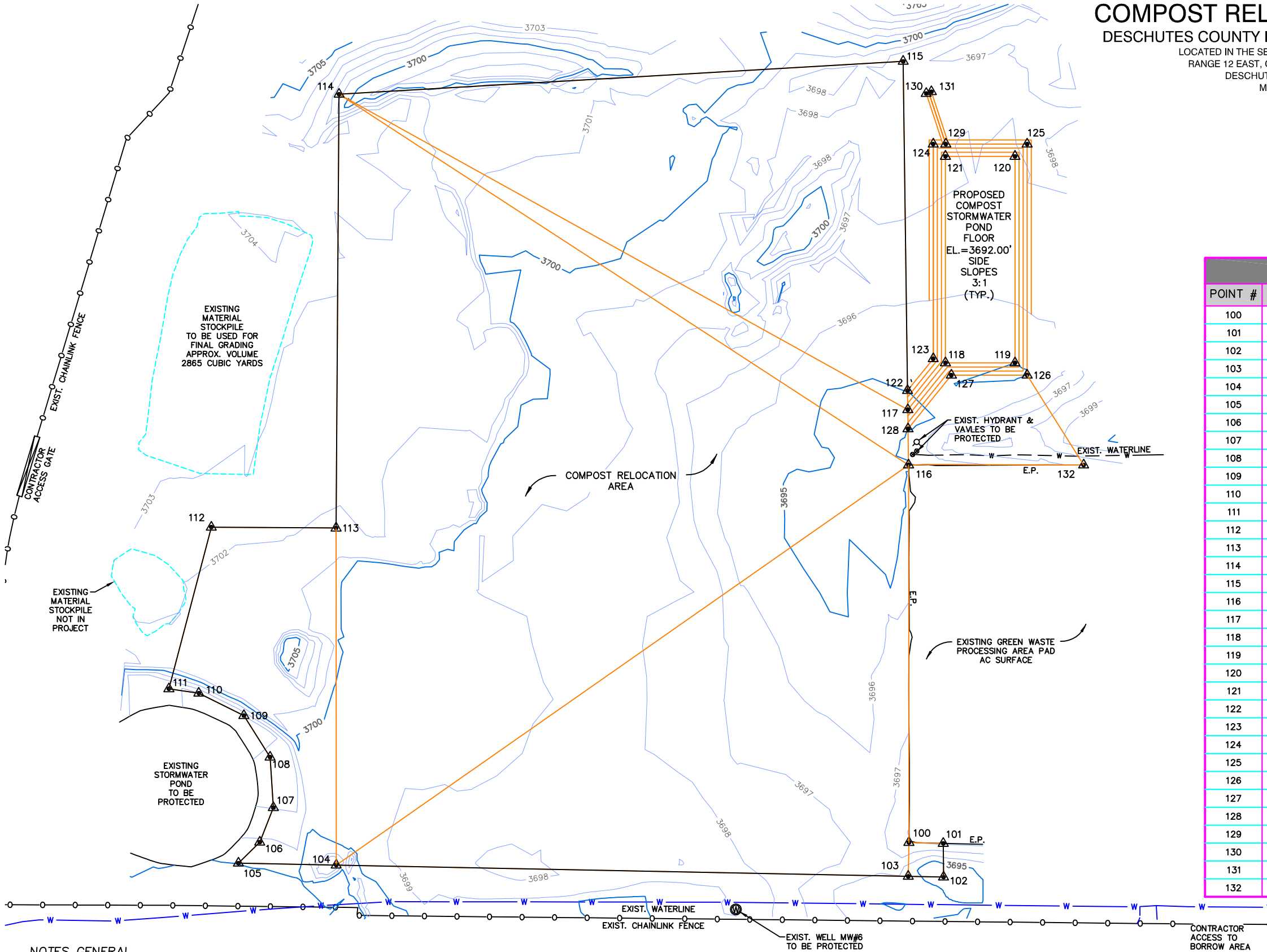
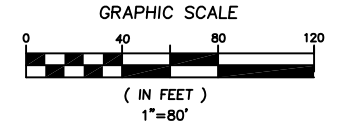

| POINT TABLE | | | |
|-------------|-----------|------------|-----------|
| POINT # | NORTHING | EASTING | ELEVATION |
| 100 | 370161.93 | 3307503.71 | 3697.50 |
| 101 | 370161.31 | 3307529.05 | 3697.61 |
| 102 | 370136.42 | 3307529.26 | 3697.91 |
| 103 | 370136.94 | 3307503.21 | 3697.80 |
| 104 | 370145.28 | 3307081.29 | 3703.07 |
| 105 | 370146.71 | 3307009.17 | 3702.00 |
| 106 | 370162.22 | 3307024.90 | 3702.00 |
| 107 | 370187.69 | 3307034.93 | 3702.00 |
| 108 | 370224.87 | 3307032.51 | 3702.00 |
| 109 | 370255.57 | 3307013.19 | 3702.00 |
| 110 | 370272.07 | 3306979.95 | 3702.00 |
| 111 | 370275.30 | 3306957.87 | 3702.00 |
| 112 | 370394.45 | 3306989.18 | 3702.00 |
| 113 | 370393.81 | 3307081.18 | 3703.07 |
| 114 | 370713.68 | 3307083.40 | 3703.07 |
| 115 | 370737.93 | 3307499.49 | 3697.86 |
| 116 | 370440.34 | 3307503.42 | 3694.41 |
| 117 | 370481.06 | 3307502.88 | 3693.80 |
| 118 | 370515.54 | 3307530.66 | 3692.00 |
| 119 | 370515.54 | 3307581.92 | 3692.00 |
| 120 | 370667.89 | 3307581.92 | 3692.00 |
| 121 | 370667.89 | 3307530.66 | 3692.00 |
| 122 | 370495.15 | 3307502.69 | 3694.02 |
| 123 | 370518.65 | 3307521.66 | 3695.00 |
| 124 | 370676.89 | 3307521.66 | 3695.00 |
| 125 | 370676.89 | 3307590.92 | 3695.00 |
| 126 | 370506.54 | 3307590.92 | 3695.00 |
| 127 | 370506.54 | 3307535.02 | 3695.00 |
| 128 | 370466.96 | 3307503.07 | 3694.01 |
| 129 | 370676.89 | 3307530.90 | 3695.00 |
| 130 | 370714.25 | 3307516.47 | 3697.00 |
| 131 | 370715.50 | 3307520.27 | 3697.00 |
| 132 | 370440.26 | 3307632.57 | 3697.26 |

NOTES GENERAL

1. THE COORDINATES SHOWN ARE BASED ON THE CENTRAL OREGON COORDINATE SYSTEM. ELEVATIONS ARE BASED ON THE VERTICAL DATUM NGVD29 AND WERE DERIVED FROM PUBLISHED CENTRAL OREGON COORDINATE SYSTEM MONUMENTS.
2. NO UNDERGROUND UTILITY FIELD LOCATION REQUEST WAS MADE FOR THIS SURVEY. VERIFY LOCATIONS PRIOR TO CONSTRUCTION
3. CONTOUR INTERVAL IS 1-FOOT.
4. EXISTING GROUND SURFACE MODEL CREATED 02-11-2016.

LINEAR UNITS: INTERNATIONAL FEET
HORIZONTAL DATUM: NAD(83-91)
VERTICAL DATUM: NGVD29

DESCHUTES COUNTY
DEPARTMENT OF SOLID WASTE
6450 SE 27TH STREET BEND, OREGON 97703
PHONE: 541-337-3463

| REVISIONS | NO. | BY | DATE | REMARKS |
|-----------|-----|----|------|---------|
| | | | | |
| | | | | |
| | | | | |
| | | | | |

| SHEET INFO | | | | |
|------------|-----|---------|------------|----|
| DRAWN | JPT | CHECKED | APPROVED | CC |
| | | | | |
| LAST EDIT | | | 02/28/2016 | |
| PLOT DATE | | | 02/28/2016 | |
| SUBMITTAL | | | | |

EXISTING SITE CONDITIONS
KNOTT LANDFILL
COMPOST RELOCATION PROJECT
DESCHUTES COUNTY DEPARTMENT OF SOLID WASTE
PROJECT NUMBER: DESX0022
DRAWING FILE NAME: DESX22BASE1
SCALE: 1"=80'

DATE: 2/28/2016 4:44 AM [AUTHOR: admin] [PLOTTER: Autodesk PDF] [STYLE: DCA-STD-STRANS] [SCALE: 1"=80'] [LAYOUT: EXIST. COND. SHEET]

KNOTT LANDFILL COMPOST RELOCATON PROJECT

DESCHUTES COUNTY DEPARTMENT OF SOLID WASTE
LOCATED IN THE SECTION 14, TOWNSHIP 18 SOUTH,
RANGE 12 EAST, OF THE WILLAMETTE MERIDIAN
DESCHUTES COUNTY, OREGON
MARCH 01, 2016

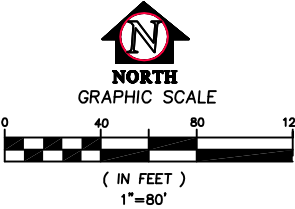

**DESCHUTES COUNTY
DEPARTMENT OF SOLID WASTE**
6160 NE 27TH STREET BEND, OREGON 97703
PHONE: 541-327-3483

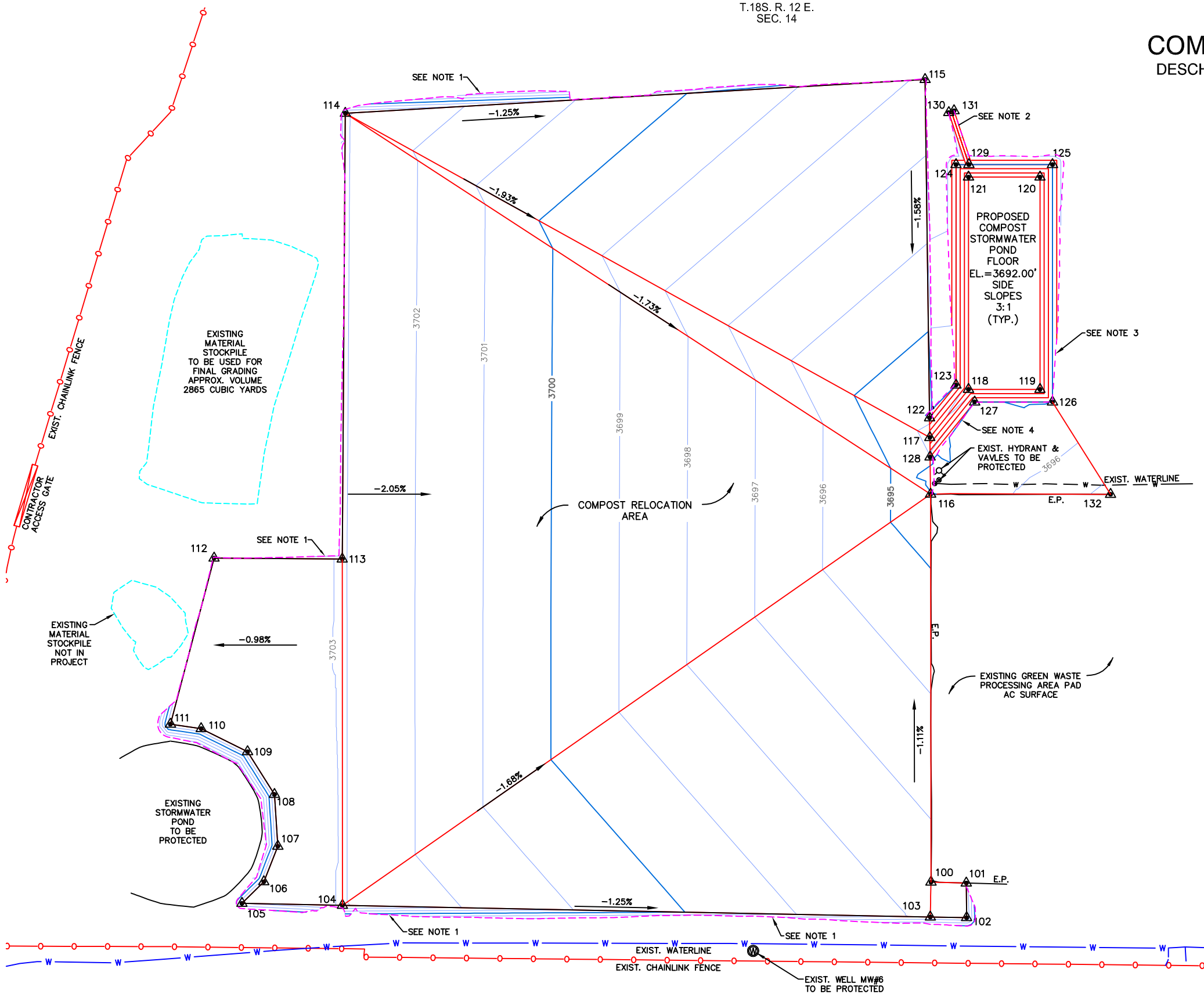

| POINT TABLE | | | |
|-------------|-----------|------------|-----------|
| POINT # | NORTHING | EASTING | ELEVATION |
| 100 | 370161.93 | 3307503.71 | 3697.50 |
| 101 | 370161.31 | 3307529.05 | 3697.61 |
| 102 | 370136.42 | 3307529.26 | 3697.91 |
| 103 | 370136.94 | 3307503.21 | 3697.80 |
| 104 | 370145.28 | 3307081.29 | 3703.07 |
| 105 | 370146.71 | 3307009.17 | 3702.00 |
| 106 | 370162.22 | 3307024.90 | 3702.00 |
| 107 | 370187.69 | 3307034.93 | 3702.00 |
| 108 | 370224.87 | 3307032.51 | 3702.00 |
| 109 | 370255.57 | 3307013.19 | 3702.00 |
| 110 | 370272.07 | 3306979.95 | 3702.00 |
| 111 | 370275.30 | 3306957.87 | 3702.00 |
| 112 | 370394.45 | 3306989.18 | 3702.00 |
| 113 | 370393.81 | 3307081.18 | 3703.07 |
| 114 | 370713.68 | 3307083.40 | 3703.07 |
| 115 | 370737.93 | 3307499.49 | 3697.86 |
| 116 | 370440.34 | 3307503.42 | 3694.41 |
| 117 | 370481.06 | 3307502.88 | 3693.80 |
| 118 | 370515.54 | 3307530.66 | 3692.00 |
| 119 | 370515.54 | 3307581.92 | 3692.00 |
| 120 | 370667.89 | 3307581.92 | 3692.00 |
| 121 | 370667.89 | 3307530.66 | 3692.00 |
| 122 | 370495.15 | 3307502.69 | 3694.02 |
| 123 | 370518.65 | 3307521.66 | 3695.00 |
| 124 | 370676.89 | 3307521.66 | 3695.00 |
| 125 | 370676.89 | 3307590.92 | 3695.00 |
| 126 | 370506.54 | 3307590.92 | 3695.00 |
| 127 | 370506.54 | 3307535.02 | 3695.00 |
| 128 | 370466.96 | 3307503.07 | 3694.01 |
| 129 | 370676.89 | 3307530.90 | 3695.00 |
| 130 | 370714.25 | 3307516.47 | 3697.00 |
| 131 | 370715.50 | 3307520.27 | 3697.00 |
| 132 | 370440.26 | 3307632.57 | 3697.26 |

NOTES GRADING

- 1. SLOPE CATCH POINT TYP. FROM HINGE POINT: 2:1 FILL & 2:1 CUT.
- 2. STORM SWALE FLAT BOTTOM WIDTH=4.0 FT. SIDE SLOPES 3:1 SLOPE CATCH POINT TYP. FROM HINGE POINT: 3:1 FILL & 3:1 CUT.
- 3. SLOPE CATCH POINT TYP. FROM HINGE POINT: 3:1 FILL & 3:1 CUT.
- 4. STORM SWALE "V" BOTTOM SIDE SLOPES 3:1 SLOPE CATCH POINT TYP. FROM HINGE POINT: 3:1 FILL & 3:1 CUT.
- 5. CONTOUR INTERVAL IS 1.0 FOOT.

| REVISIONS | NO. | BY | DATE | REMARKS |
|-----------|-----|----|------|---------|
| | | | | |
| | | | | |
| | | | | |
| | | | | |
| | | | | |
| | | | | |
| | | | | |
| | | | | |
| | | | | |

| SHEET INFO | DRAWN | JPT | CHECKED | CC | APPROVED | CC | LAST EDIT | DATE | PLOT DATE | SUBMITTAL |
|------------|-------|-----|---------|----|----------|----|-----------|------------|-----------|------------|
| | | | | | | | | 02/28/2016 | | 02/28/2016 |

SUBGRADE PLAN
KNOTT LANDFILL
COMPOST RELOCATION PROJECT
DESCHUTES COUNTY DEPARTMENT OF SOLID WASTE

PROJECT NUMBER: DESX0022
DRAWING FILE NAME: DESX22BASE1
SCALE: 1"=80'

SHEET NUMBER: **2**
OF 4 SHEETS

[DATE: 2/28/2016 4:44 AM] [AUTHOR: admin] [PLOTTER: Autodesk PDF 240] [STYLE: DCA-STD-STA.dwg] [SCALE: 1"=80'] [DATE: 2/28/2016 4:44 AM] [AUTHOR: admin] [PLOTTER: Autodesk PDF 240] [STYLE: DCA-STD-STA.dwg] [SCALE: 1"=80']

KNOTT LANDFILL COMPOST RELOCATON PROJECT

DESCHUTES COUNTY DEPARTMENT OF SOLID WASTE
LOCATED IN THE SECTION 14, TOWNSHIP 18 SOUTH,
RANGE 12 EAST, OF THE WILLAMETTE MERIDIAN
DESCHUTES COUNTY, OREGON
MARCH 01, 2016

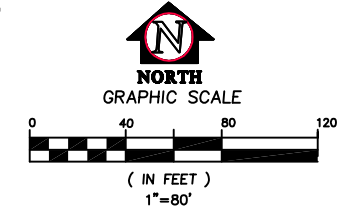

| ELEVATIONS TABLE | | | |
|------------------|---------------|---------------|-------------|
| NUMBER | MINIMUM ELEV. | MAXIMUM ELEV. | COLOR |
| 1 | -5.161 | -4.000 | Red |
| 2 | -4.000 | -3.000 | Orange |
| 3 | -3.000 | -2.000 | Yellow |
| 4 | -2.000 | -1.000 | Light Green |
| 5 | -1.000 | 0.000 | Green |
| 6 | 0.000 | 1.000 | Cyan |
| 7 | 1.000 | 2.000 | Blue-Cyan |
| 8 | 2.000 | 3.000 | Blue |
| 9 | 3.000 | 4.000 | Dark Blue |
| 10 | 4.000 | 5.297 | Purple |

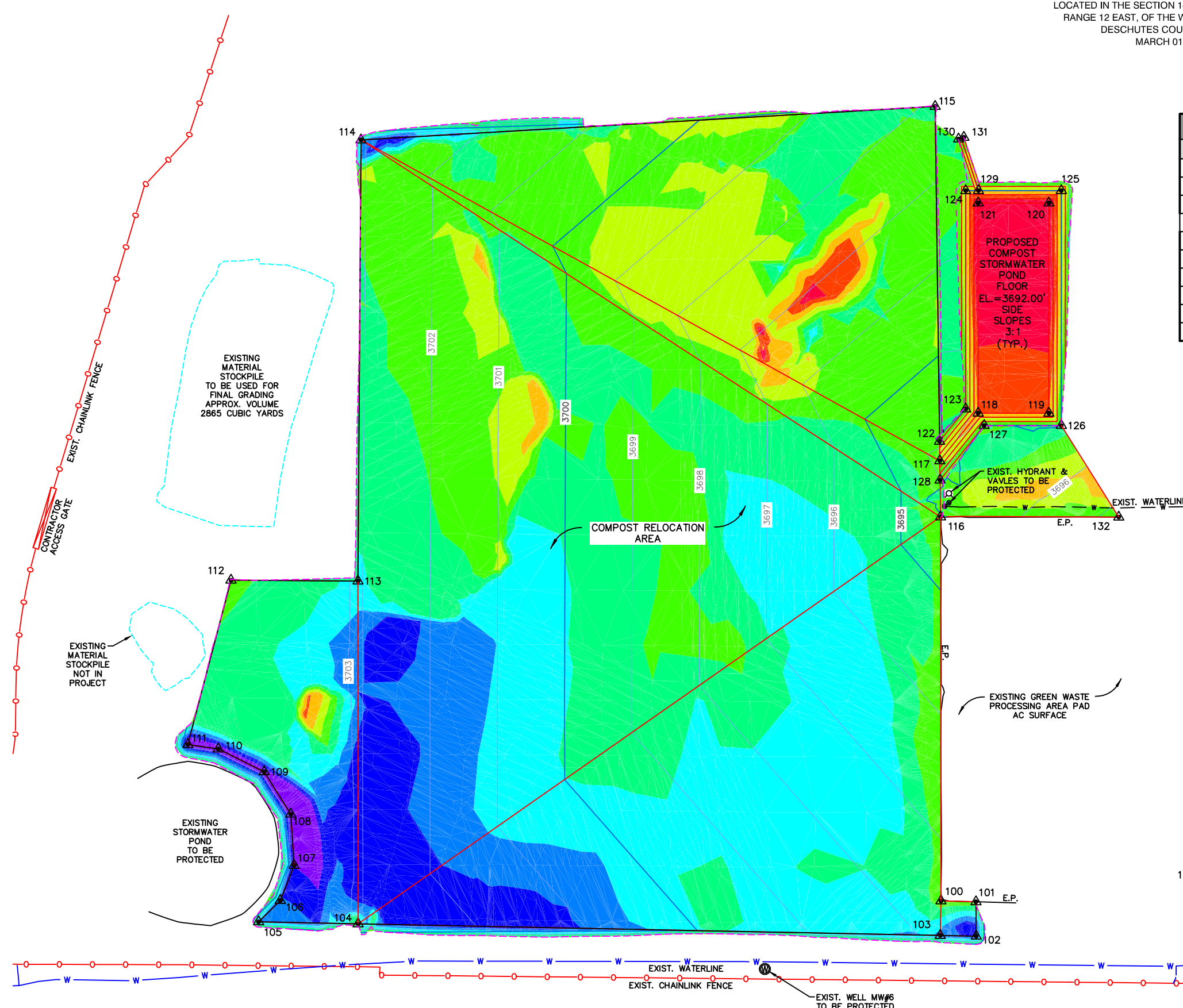

NOTES GRADING & SITE VOLUMES

SITE VOLUME REPORT

SITE WORK AREA
 BASE SURFACE EG01_02-16-2016
 COMPARISON SURFACE SG01_02-17-2016
 CUT FACTOR 1.00
 FILL FACTOR 1.00
 CUT VOLUME (UNADJUSTED) 4687 CU. YD.
 FILL VOLUME (UNADJUSTED) 8336.23 CU. YD.
 NET VOLUME (UNADJUSTED) 3649 CU. YD.<FILL>

EXISTING MATERIAL STOCKPILE
 FILL VOLUME (UNADJUSTED) 2865 CU. YD.<FILL>

NET SITE VOLUME TOTAL (UNADJUSTED) 784 CU. YD.<FILL>

NOTES GRADING & SITE VOLUMES

- ALL VOLUMES ARE IN PLACE VALUES. NO EXPANSION OR CONTRACTION FACTORS HAVE BEEN APPLIED.

DESCHUTES COUNTY DEPARTMENT OF SOLID WASTE
 6160 E 27TH STREET BEND, OREGON 97702
 PHONE: 541-337-3483

SUBGRADE PLAN CUT AND FILL DEPTHS
 KNOTT LANDFILL
 COMPOST RELOCATION PROJECT
 DESCHUTES COUNTY DEPARTMENT OF SOLID WASTE

PROJECT NUMBER: DESX0022 DRAWING FILE NAME: DESX22BASE1 SCALE: 1"=80'

SHEET NUMBER: **3**
 OF 4 SHEETS

DATE: 2/28/2016 4:30 AM [AUTHOR: admin] [PLOTTER: Autodesk PDF Plotter] [STYLE: DCA-STD-STR-USA] [LAYOUT: CUT-FILL SHEET]
 PATH: L:\Projects\Reserve\Projects\DESX0022-1001\Draw-2016\DESX22BASE1.dwg [LAYOUT: CUT-FILL SHEET]

REF. NO.

T.18S. R. 12 E.
SEC. 14

KNOTT LANDFILL COMPOST RELOCATION PROJECT

DESCHUTES COUNTY DEPARTMENT OF SOLID WASTE

LOCATED IN THE SECTION 14, TOWNSHIP 18 SOUTH,
RANGE 12 EAST, OF THE WILLAMETTE MERIDIAN
DESCHUTES COUNTY, OREGON
MARCH 01, 2016



DESCHUTES COUNTY
DEPARTMENT OF SOLID WASTE
6000 SE 27TH STREET BEND, OREGON 97703
PHONE: 541-371-3433

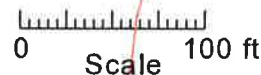
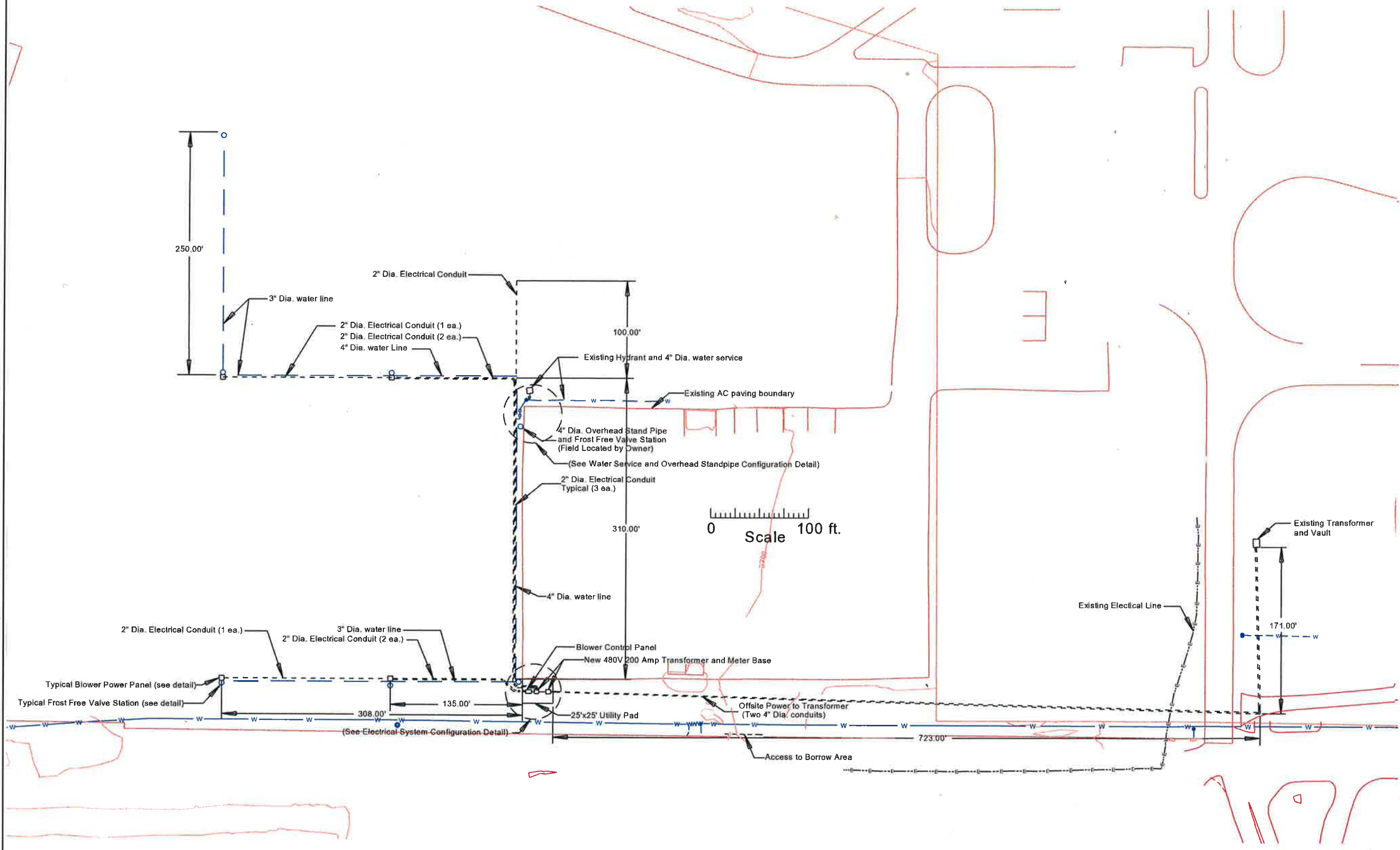

| NO. | BY | DATE | REMARKS |
|-----|----|------|---------|
| | | | |
| | | | |
| | | | |
| | | | |
| | | | |
| | | | |
| | | | |
| | | | |
| | | | |
| | | | |

| SHEET INFO | |
|------------|------------|
| DRAWN | JM |
| CHECKED | CC |
| APPROVED | CC |
| LAST EDIT | 02/28/2016 |
| PLOT DATE | 02/28/2016 |
| SUBMITTAL | |

UTILITY PLAN
KNOTT LANDFILL
COMPOST RELOCATION PROJECT
DESCHUTES COUNTY DEPARTMENT OF SOLID WASTE

PROJECT NUMBER: DESX0022
 DRAWING FILE NAME: DESX22BASE2
 SCALE: 1"=100'

SHEET NUMBER
4
OF 4 SHEETS

DATE: 2/24/2016 3:33 pm | AUTHOR: adam | C:\Users\adam\OneDrive\Documents\2016\20160224\20160224.dwg | USER: adam