

**GUIDEBOOK TO
WILDLIFE
FRIENDLY
FENCING**

The publishers of this guidebook recognize the significant contributions of the following individuals to the production of this handbook: Jon Nelson, Wildlife Biologist; Alysia Wolf, Wildlife Biologist; Sara Gregory, Wildlife Biologist, Oregon Department of Fish and Wildlife; and Suzanne Linford, Executive Director, Protect Animal Migration.

Their efforts on the part of Oregon's wildlife are greatly appreciated.

Tim Greseth, Executive Director, the Oregon Wildlife Foundation, 2021.

Cover photo by Jon Nelson

All rights reserved, 2021.

Table of Contents

Introduction.....	1
Challenges with conventional fencing	2
Fencing hazards for birds	4
Ways to improve or modify existing fencing.....	5
Measurements for wildlife friendly fencing on flat ground	6
Measurements for wildlife friendly fencing on sloped ground.....	8
Wildlife friendly residential fencing.....	9
Volunteers helping wildlife	10
Sources	11

Introduction

Thousands of miles of fence crisscross the Western United States. They enclose pastures and yards, outline property boundaries, and prevent domestic animals from straying.

Fencing intended for domestic animals often fragments wildlife habitat and can restrict access to resources (forage, cover, fawning grounds, mates, etc.). Poorly designed fencing may also interrupt seasonal migrations essential to populations of species such as mule deer and pronghorn.

When wild animals collide with wires or attempt to cross impassable fence, they can be injured or killed. Damage to fences after unsuccessful crossing attempts generate maintenance costs for landowners and can create openings where domestic animals can escape.

Not all fences are problematic for wild animals. Wildlife-friendly designs can save time and money in the long run by reducing damage. Thoughtfully constructed fences can be compatible with both the need to contain domestic animals and the movements of wild species.



— PROTECT —
ANIMAL MIGRATION
For Barrier Free Safe Passage

OREGON WILDLIFE
FOUNDATION

PROTECT ANIMAL MIGRATION, an educational non-profit with the Oregon Wildlife Foundation, working in cooperation with state agencies and other partners, has compiled the following guidelines to assist landowners in the design of wildlife friendly fencing in Oregon.

Before construction, consult with the Oregon Department of Fish and Wildlife and appropriate land management agencies regarding fence ordinances.

Challenges With Conventional Fencing

Traditional fence designs can be a problem for wild animals that attempt to pass over, under, or through the barrier to access the resources they need for survival. Young, pregnant, and winter-stressed individuals can have a particularly difficult time clearing fences. If animals become entangled, they can suffer from injuries, dehydration, and stress. These factors may reduce an animal's chance of survival, or even kill it outright.

Woven-wire fences, especially when topped with barbed wire, are the most dangerous fence to wildlife (Harrington and Conover 2006). They can be a serious barrier to fawns and calves that are incapable of passing over, under, or through the mesh, separating them from their mothers who manage to jump over. The young often curl up by the fence where they may eventually perish from exposure and dehydration. Woven wire is often equally impassable for medium sized animals such as black bears that do not have the ability to jump over but are too large to pass through.



Woven-wire fence topped with barbed wire.

Photo: Alysia Wolf



Fence posts that are too close together can trap small animals. This deer fawn dislocated its hips trying to pass between posts.

Photo by ODFW



Deer fawn unable to pass an impenetrable woven wire fence.

Photo: George Lepp

Fencing Hazards For Birds

Birds including sage grouse and raptors can also have deadly run-ins with fencing. Trauma caused by collisions with near-invisible wire, impalement on barbs, or death due to entanglement are all threats birds face.



Great horned owl caught in barbed wire fence.

Photo: Gary Landers

Ways To Improve Or Modify Existing Fencing

Many fence-related bird injuries and mortalities can be corrected by modifying the wire strands to be more visible. Visible fencing also aids other wildlife in judging the height of a fence to prevent entanglements and fence damage.

- Adding reflective or colorful weather-resistant tags or flagging to the top wire alerts animals to the presence of fencing.
- Enclose the top wire in a length of black HDPE pipe.
- Cap the tops of round hollow posts to prevent birds from becoming trapped inside.



Fencing with reflectors for added visibility in sage grouse habitat. *Photo: Alysia Wolf*

Modify Existing Fences When Animals Are Migrating Between Their Summer And Winter Ranges:

- Install staple locks to clip the top and second wire together to reduce height. Lowering the top wire to 25" or less allows elk and deer to hop over easily (Figure 1).
- Clip the bottom wire to the wire directly above it to help wildlife crawl under (Figure 2).
- After moving livestock, leave gates open as a temporary migration corridor.
- Drop the top rail (Figures 3 & 4).

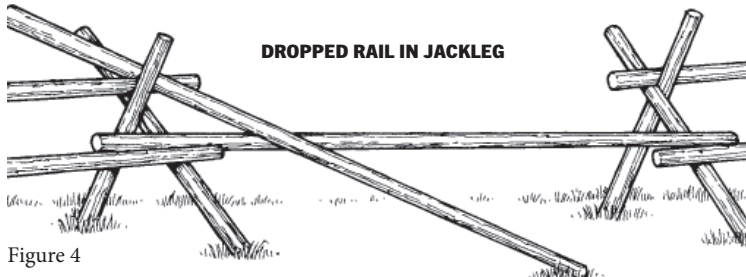
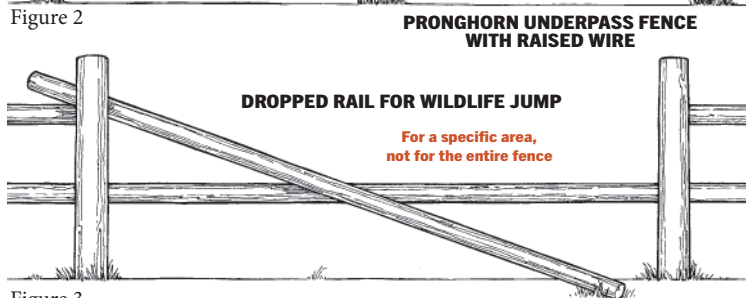
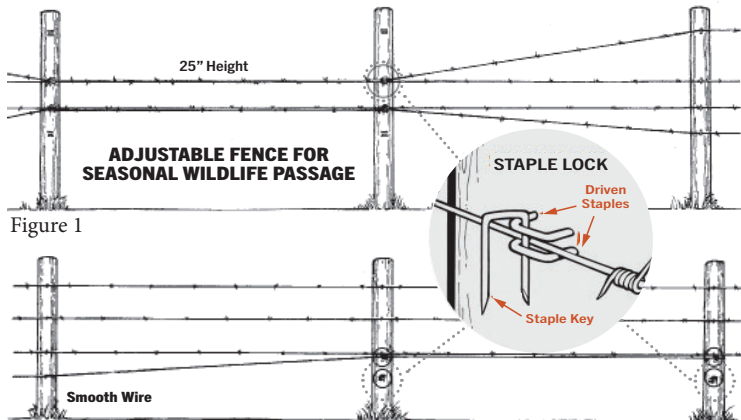

Design Considerations For New Fencing

When designing your fence, think about the species of wildlife present and their daily or seasonal movements in your area. Special considerations should be made based on the topography of the ground being fenced. The following measurements are suggested for barrier free safe passage. Before construction, consult with the Oregon Department of Fish and Wildlife and other appropriate land management agencies for compliance with and fence ordinances.

Measurements For Fencing On Flat Ground

- Maximum height of 42 inches.
- 3-4 wires in total.
- Use strands of smooth wire for top and bottom.
- Use barbed wire for the second or third wire only.
- Add a PVC cover on the top wire for visibility.
- Avoid the use of woven wire.
- Allow at least 12 inches between the top two wires to reduce leg entanglements.
- Leave 16-18 inches between the bottom wire and the ground to allow wildlife to travel beneath.

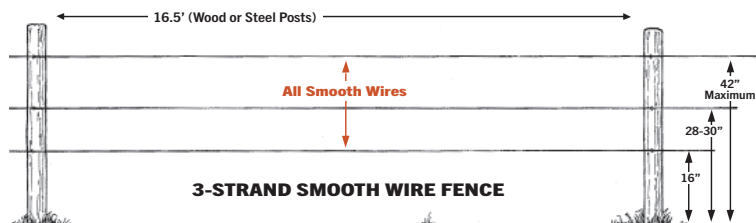
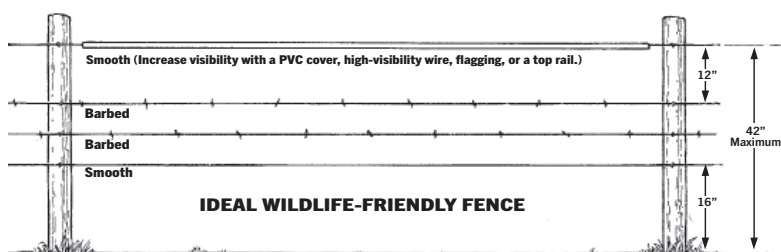

Post And Rail Fence or Post And Wire Fence

- Limit fence height to 42 inches.
- Place smooth lower wire at 16 inches above the ground for younger animals to pass through.
- Place second wire at least 12 inches below the top rail.

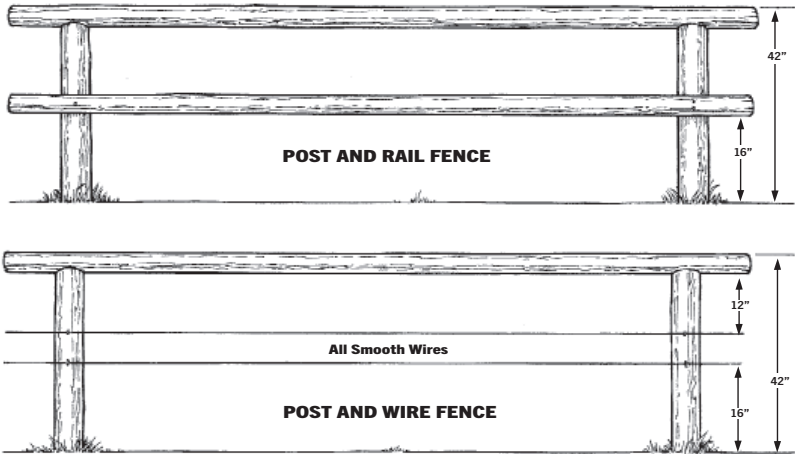

Image: Colorado Division of Wildlife



This wildlife-friendly fence has a smooth top wire and adequate space below the bottom wire, allowing ungulates to pass over or under the barrier.

Photo: Jon Nelson

Measurements For Fencing On Sloped Ground

Fences on steep slopes are nearly impossible for animals to jump over without a collision or entanglement occurring.

As ground slope increases, the height an animal must jump to clear the fence increases.

- When slope is 0% and the fence is on level ground, fence height is 42".
- When slope is 30%, fence height increases to 62".
- When slope is 50%, fence height for animals is 75".

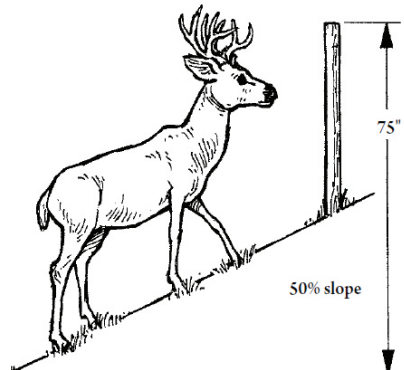
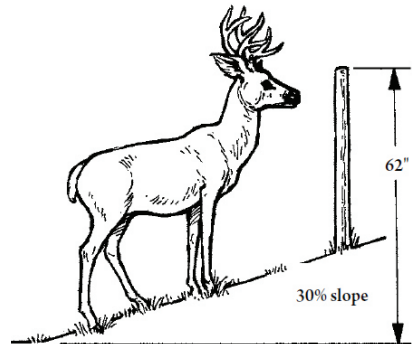
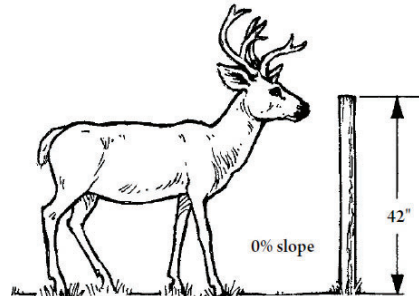

Image: Montana FWP

More Helpful Tips

An occasional gap in the fence can also provide a crossing for animals moving its length seeking an opening. Dropping rails every 400' allows animals to step across. Rails should be dropped where there are signs of wildlife passage such as game trails or seasonal use.

A lay-down fence is a standard 3 or 4-wire or woven-wire fence that can be laid on the ground as a unit to allow ungulates to pass through during migration or seasonal use.

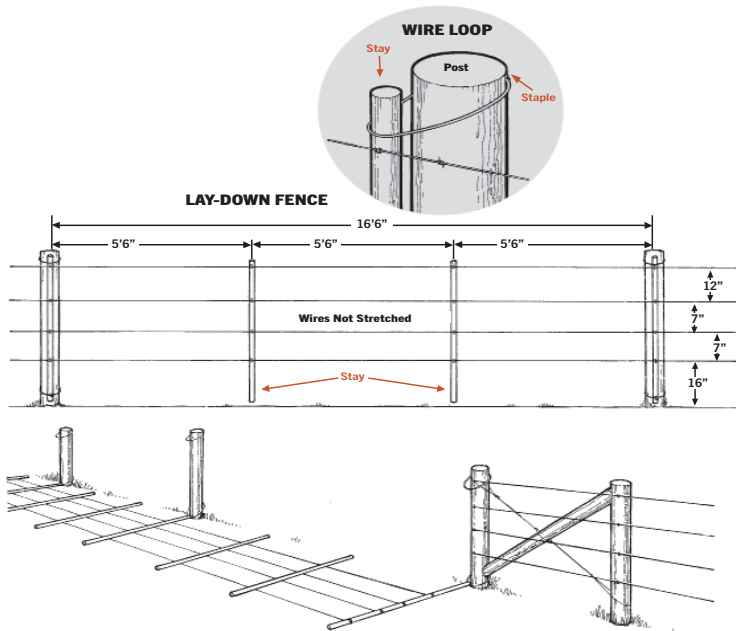

Image: Colorado Division of Wildlife

Wildlife Friendly Residential Fencing

Residential fencing can also prevent wildlife movement. While aesthetics and pet safety are often priorities, there are considerations for homeowners who want to be friendly to wildlife.

- Is fencing necessary? Landscaping or privacy screens may achieve the same goals without endangering wildlife.
- Reconsider wrought iron or fencing with metal pickets which can potentially impale animals that attempt to cross them. Avoid fencing with pointed extensions on the top.
- Use vinyl coated top wires or top rails on any type of fence for increased visibility. This added feature will help wildlife better judge the height of a fence, decreasing collisions, entanglements, and fence damage.
- Use smooth wire rather than woven wire.



Photo: Oregon Dept. of Fish and Wildlife

Volunteers Helping Wildlife



Removal of unneeded fencing

Photo: Jon Nelson

Wildlife friendly fencing is good stewardship that supports the needs of wild animals to move across our shared landscape. As recreational demands on our public land increase and barriers to movement grow, the fate of species like mule deer is at stake. Public agencies cannot help wildlife populations thrive without community support. Volunteers can help by removing unneeded fencing that threatens wildlife.

The Oregon Hunters Association (OHA), Rocky Mountain Elk Foundation (RMEF), and the Oregon Natural Desert Association (ONDA) are but a few non-profit organizations working with the Bureau of Land Management and other agencies in Central Oregon to remove derelict fences that trap animals, especially elk calves and deer fawns. OHA maintains miles of fencing along Highway 97 that funnels animals to a wildlife crossing near Sunriver. Collectively, these and other organizations put in many volunteer hours to improve wildlife passage and movement in Central Oregon.

Sources

Arizona Game and Fish, Wildlife Compatible Fencing

Bureau of Land Management, USDA Forest Service, Technology and Development Program; Society for Range Management, Fences, Second Printing, 1999

Bureau of Land Management Manual, H-1741-1, Chapter 4, Fencing. Rev. 12/6/89

Bugle Magazine, Rocky Mountain Elk Foundation, Jan/Feb. 2018. Mending Fences – Wildlife Friendly Fencing, by Christina Page, wildlife biologist, Driggs. Idaho.

Colorado Division of Wildlife, Fencing with Wildlife in Mind

Montana Fish, Wildlife and Parks, A Landowner's Guide to Wildlife Friendly Fences; How to Build a Fence with Wildlife in Mind, Second Ed., 2012.

Natural Resources Conservation Service, Department of Agriculture, Oregon Department of Fish and Wildlife, Deer Fences/Elk Fences

Utah State University, Department of Forest, Range and Wildlife Sciences. Characteristics of Ungulate Behavior and Mortality Associated with Wire Fences, Justin L. Harrington, 2005.

Western Association of Fish and Wildlife, Fact Sheet #13, Understanding Mule Deer and Fencing

Wyoming Game and Fish Department, Fencing Guidelines for Wildlife, Rev., Habitat Extension Bulletin, No 53; USDI Bureau of Land Management, USDI Forest SII

Wyoming Wildlife Foundation. A Wyoming Landowner's Handbook to Fences and Wildlife, Practical Tips for Fencing with Wildlife in Mind

Justin L. Harrington, and Michael R. Conover. "Characteristics of Ungulate Behavior and Mortality Associated with Wire Fences." *Wildlife Society Bulletin* (1973-2006), vol. 34, no. 5, 2006, pp. 1295–1305. www.jstor.org/4134262. Accessed 10 Aug. 2021.



———— PROTECT ————
ANIMAL MIGRATION

For Barrier Free Safe Passage

PAM partners with public agencies and non-profits to advocate for barrier free and safe movement of mule deer, elk, antelope and many other wildlife species.

OREGON WILDLIFE
FOUNDATION

Conserving Oregon's fish and wildlife since 1981.
For more information, visit www.myowf.org